

INSTRUCTION MANUAL

FT-7

SERVICE



For Service Manuals Contact
MAURITRON TECHNICAL SERVICES
8 Cherry Tree Rd, Chinnor
Oxon OX9 4QY
Tel: 01844-351694 Fax: 01844-352554
Email: enquiries@mauritron.co.uk

YAESU MUSEN CO., LTD.

TOKYO JAPAN

HF MOBILE TRANSCEIVER
FT-7

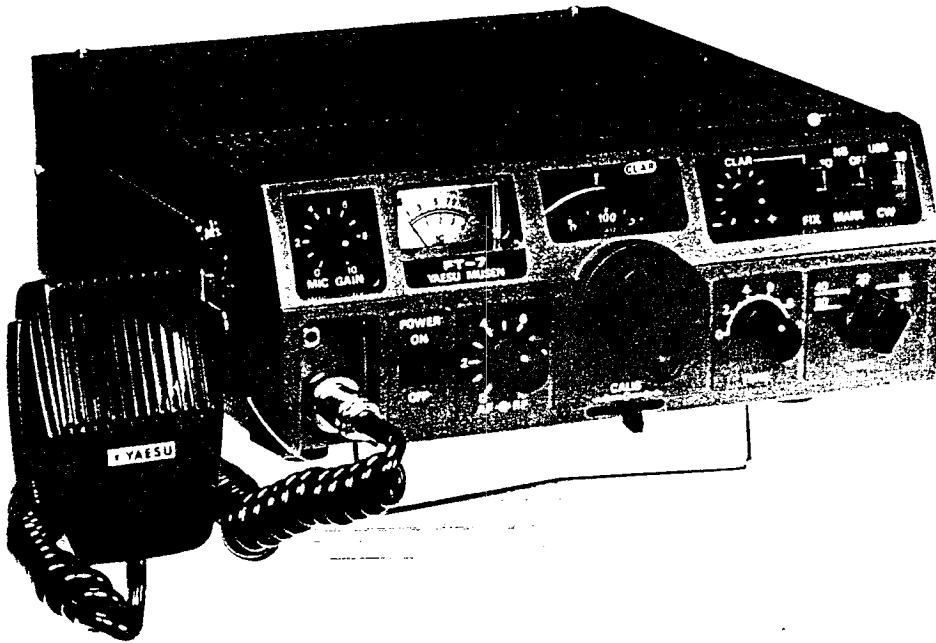

The all-solid-state FT-7 mobile transceiver provides high performance on the 80 through 10 meter bands. The operator may select upper or lower sideband (USB, LSB) or CW operation, and the compact package contains many features engineered for maximum convenience during mobile operation.

The TUNE control provides single-knob peaking of all transceiver circuits, thus eliminating inconvenient plate and load controls. Transmitter final amplifier input power is 20 watts DC. A high performance noise blanker minimizes impulse-type noise such as that commonly found in mobile applications. Also built-in are a 100 kHz crystal calibrator and receiver offset tuning (clarifier). For CW operation, semi-break-in with sidetone is provided.

The receiver front end utilizes MOS FET and Schottky diode circuitry for maximum sensitivity and immunity from overload.

The operator may select between either the internal VFO or a fixed (crystal controlled) channel. An external VFO may be used with the FT-7 to provide either VFO or crystal control of the transmit and/or receive frequency.

The FT-7 operates directly from a 13.5 VDC power source. For base station operation, the FP-7 or FP-4 power supply may be used to provide the necessary voltage.

In order to derive the maximum satisfaction from your new FT-7, we recommend that you read this instruction manual thoroughly so as to understand fully the functions of the controls and switches.

SPECIFICATIONS

Frequency coverage: 80m 3.5-4.0 MHz
40m 7.0-7.5 MHz
20m 14.0-14.5 MHz
15m 21.0-21.5 MHz
10m *28.5-29.0 MHz

*28.5-29.0 MHz crystal installed, other crystals available as an option

Power requirements: 13.5 VDC \pm 10%

Power consumption: 13.5 VDC--3A transmit, 0.4 A receive

Dimensions: 230 (W) x 80 (H) x 290 (D) mm

Weight: 5 kg.

TRANSMITTER

Emission: LSB, USB (A3J) CW (A1)

Input power: A1, A3j, 20 watts DC

Carrier suppression: Better than 50 dB below rated output

Unwanted sideband suppression: Better than 50 dB @ 1000 Hz

Spurious emission: Better than -40 dB

Distortion products: Better than -31 dB

Transmitter frequency response: 350-2700 Hz -6 dB

Frequency stability: Less than 300 Hz drift from a cold start;
less than 100 Hz over a 30 minute period
after warm-up.

Antenna output impedance: 50 ohms nominal

Microphone input impedance: 500 Ohms nominal

RECEIVER

Sensitivity: 0.25 uV for S/N 10 dB

Image rejection: Better than 50 dB

IF rejection: Better than 50 dB

Selectivity: -6 dB: 2.4 KHz
-60 dB: 4.0 KHz

Audio output: 3 watts @ 10% THD

Audio output impedance: 4 Ohms

For Service Manuals Contact
MAURITRON TECHNICAL SERVICES
8 Cherry Tree Rd, Chinnor
Oxon OX9 4QY
Tel: 01844-351694 Fax: 01844-352554
Email: enquiries@mauritron.co.uk

SEMICONDUCTORS

Silicon Transistors:

2SA628A	(1)	MCI4011B	(1)
2SC372Y	(13)	TA7053P	(1)
2SC373	(1)	TA7205P	(1)
2SC535A	(1)	uPC14308	(1)
2SC735Y	(1)	Schottky-barrier silicon diode	
2SC784R	(1)	1SS16	(4)
2SC1000GR	(1)	Germanium diode	
2SC1589	(1)	1N60	(8)
2N4427	(2)	1S1007	(13)
MPSA13	(1)	Silicon diode	
MRF433	(2)	1S1555	(20)

FET

2SK19GR	(8)	10D10	(1)
2SK19Y	(3)	U05B	(1)
3SK40M	(9)	Varactor diode	
JF1033B	(1)	1S2236	(1)

IC

F4024PC	(1)	Zener diode	
MC1496G	(1)	WZ090	(1)
		YZ033	(1)

ACCESSORIES

The following accessories are packaged along with your transceiver.

- (1) **POWER CORD**
The red and black power cord is three meters long, and it comes equipped with a 6-prong connector at one end. In the middle of the cord there is a holder for the six Amp fuse for the DC line. The red wire should be connected to the positive side of the vehicle battery, and the black side is connected to the negative side.
- (2) **MICROPHONE**
The microphone is attached to the transmitter through a four conductor screw-on connector. As shown in the diagram, pin 1 is the COMMON connection, pin 2 is the mic lead, and pin 3 is the PTT (push-to-talk) connection.
- (3) **COAXIAL CONNECTOR**
A standard M-type ("UHF") coax connector is included for installation on coax feedline.
- (4) **MINIATURE PHONE PLUGS**
These two miniature phone plugs are included for installation on (1) the headphone cable, and (2) the key lead.
- (5) **PLUG ADAPTER**
When the key lead already has a standard 1/4" phone plug installed, this adapter will allow the lead to be used without installation of a new connector.
- (6) **MOBILE MOUNTING BRACKET**
This bracket is to be installed in a convenient place (under the dash board, in most cases) to allow quick installation of the transceiver.
- (7) **EXTRA FUSE**
An extra fuse for the DC lead is included in the event that the original fuse blows. Replacement fuses should be rated for 6 Amps, slow-blow.

MOBILE INSTALLATION

For mobile service, the FT-7 should be installed where the controls, indicators, and microphone are easily visible and accessible for operation. The unit may be mounted in any position without loss of performance. Suitable locations are under the dash, atop transmission tunnel, etc. A universal mounting bracket is supplied with the transceiver for this purpose. Install the FT-7 as follows:

1. Use the universal mounting bracket as a template to locate the mounting holes. Use a 3/16" diameter drill for these holes and allow clearance for the transceiver, its controls, and all connecting cables. Secure the mounting bracket with the screws, washers, and nuts that are supplied, as shown in figure 1.
2. Install the transceiver on the mounting bracket using four screws, two on each side. The angle of the transceiver with respect to the bracket may be varied by changing mounting holes.
3. The microphone hanger may be affixed to any convenient place for access to the microphone.

For Service Manuals Contact
MAURITRON TECHNICAL SERVICES
8 Cherry Tree Rd, Chinnor
Oxon OX9 4QY
Tel: 01844-351694 Fax: 01844-352554
Email: enquiries@mauritron.co.uk

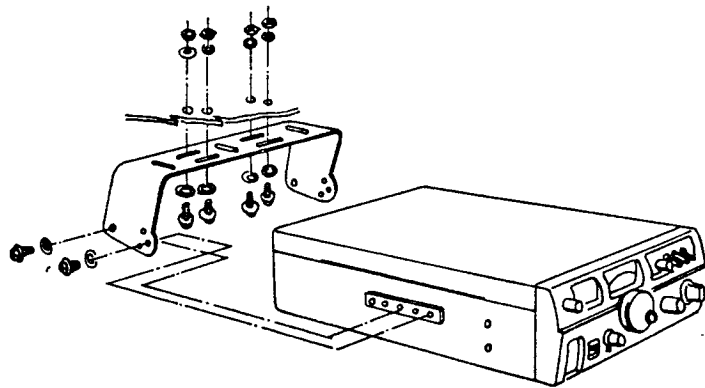

4. The supplied power cable may be plugged directly into the vehicle's cigarette lighter receptacle for casual operation if desired. For permanent installation, the lighter plug may be removed and the leads routed directly to the battery (red positive, black negative/ground), or the nearest termination to the battery, e.g. ignition switch, fuse block, etc. If it is necessary to extend the power leads over a considerable distance, use #16AWG insulated copper wire and do not extend the leads further than necessary to avoid excessive voltage drop.

CAUTION

BEFORE CONNECTING THE POWER CABLE TO THE TRANSCIEVER, CHECK THE BATTERY VOLTAGE WITH THE ENGINE RUNNING (BATTERY CHARGING). IF THE VOLTAGE EXCEEDS 15 VOLTS DC, THE REGULATOR SHOULD BE READJUSTED SO THE HIGHEST CHARGING RATE DOES NOT EXCEED 15 VOLTS. ALSO, BE SURE TO OBSERVE PROPER POLARITY WHEN MAKING BATTERY CONNECTIONS (REVERSED POLARITY WILL NOT DAMAGE THE FT-7 DUE TO THE PROTECTIVE CIRCUITRY INCORPORATED IN THE DESIGN. HOWEVER, THE EQUIPMENT WILL NOT OPERATE UNDER THIS CONDITION).

5. Connect the power cable to the POWER receptacle on the rear panel.
6. Connect a 50 Ohm antenna feedline to the ANT receptacle on the rear panel.
7. Connect the microphone cable to the 4-pin microphone receptacle on the front panel.
8. Connect a key, if desired, to the KEY jack on the rear panel.
9. An external 4 Ohm speaker may be connected to the SP receptacle on the rear panel if desired (this automatically disconnects the internal speaker). Use the external speaker plug provided.

BASE STATION INSTALLATION

As a base station, the FT-7 requires a source of 13.8 VDC at 3.0 amperes. The FP-7, FP-4, FP-301, and FP-301D AC power supplies will provide the necessary power.

FRONT PANEL CONTROLS

For Service Manuals Contact
MAURITRON TECHNICAL SERVICES
8 Cherry Tree Rd, Chinnor
Oxon OX9 4QY
Tel:- 01844-351694 Fax:- 01844-352554
Email:- enquiries@mauritron.co.uk

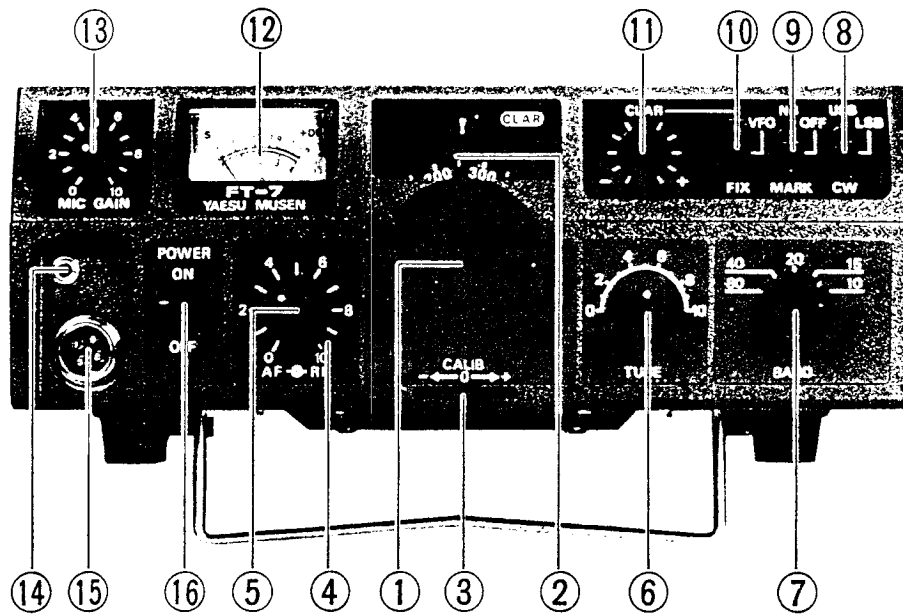

- (1) TUNING KNOB
This knob controls the main VFO frequency. One revolution of the knob covers 16 KHz of bandspread.
- (2) DIAL
The main tuning dial has numerical calibrations every 10 KHz, and marks every 1 KHz. The sub-dial is numerically calibrated every 100 KHz, with an additional mark every 50 KHz.
- (3) CALIB
When the MARK switch is activated, the 100 KHz calibrator becomes operational, and the CALIB control allows zeroing the calibrator signal with the tuning dial calibration mark.
- (4) RF GAIN
The RF GAIN control varies the gain of the receiver RF and IF amplifiers. Clockwise rotation increases the gain level.
- (5) AF GAIN
The AF GAIN control varies the audio output level at the speaker and earphone jack. Clockwise rotation increases the gain level.
- (6) TUNE
This control tunes all the transceiver signal circuits for the frequency being used.
- (7) BAND
The BAND switch selects the frequency band desired. Coverage of 80 through 10 meters is provided.
- (8) MODE
The MODE switch chooses the desired mode: USB, LSB, or CW.

- (9) NB/MARK
 When this switch is placed in the NB position, the noise blanker circuitry is activated.
 When placed in the MARK position, the 100 KHz calibrator is activated for calibrating the main tuning dial.
- (10) CLAR/VFO/FIX
 This switch determines the source of frequency control. In the VFO position, frequency control is by means of the FT-7 main dial VFO. In the CLAR position, frequency control is still by means of the main VFO, but the clarifier control will allow receiver offset tuning of ± 2 KHz. In the FIX position, crystal control of the transceiver frequency is possible.
 When the CLAR or FIX positions are used, a small light will so indicate in the window above the main tuning dial.
- (11) CLARIFIER
 This control allows ± 2 KHz receiver offset tuning without affecting the transmitter frequency, when the switch (10) is placed in the uppermost position.
- (12) METER
 The front panel meter functions as an S meter while on receive. In the transmit condition, the meter reads collector current for the final amplifier transistors on a scale of 0-4 Amps.
- (13) MIC GAIN
 This control varies the gain of the microphone amplifier stage. Clockwise rotation increases the microphone amplifier gain.
- (14) EAR
 This jack accommodates a 4-8 Ohm headphone through a miniature phone plug. When the plug is inserted into this jack the external speaker jack and the internal speaker are disconnected.
- (15) MIC
 A four-pin socket accommodates the microphone plug for microphone and PTT input.
- (16) POWER
 This is the main power ON/OFF switch.

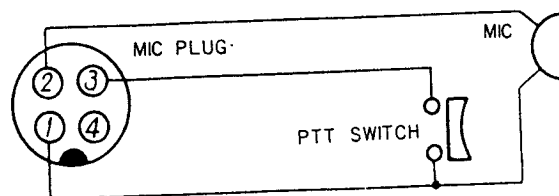

Microphone plug connection

REAR APRON CONNECTIONS

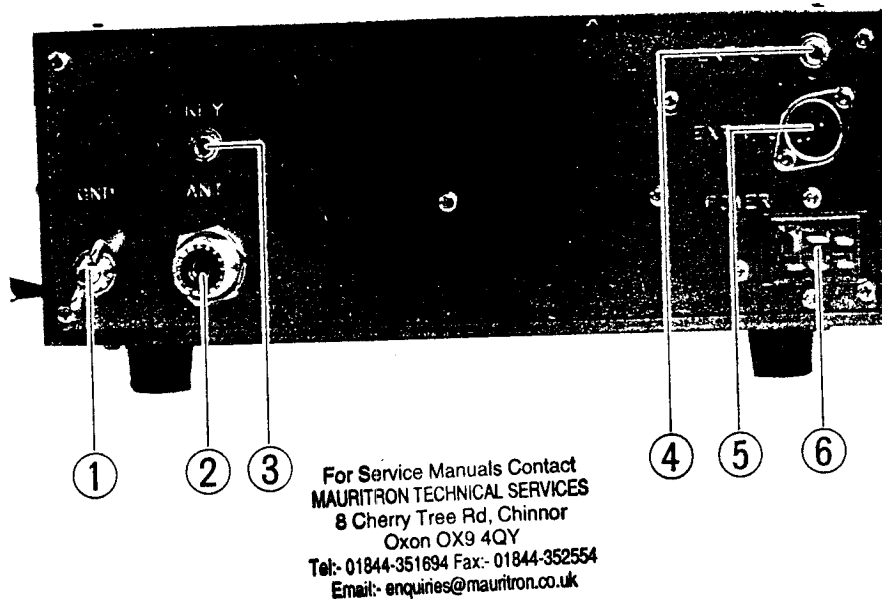

- (1) GND
Ground connection to car body or earth ground.
- (2) ANT
This is a standard M ("UHF") female coaxial connector for the antenna feedline.
- (3) KEY
For CW operation, the key plug (miniature phone type) is inserted into this jack.
- (4) EXT SP
An external 4 Ohm speaker may be connected to this jack.
- (5) EXT VFO
This socket provides connections for an external VFO.
- (6) POWER
The main power cord is connected at this point.

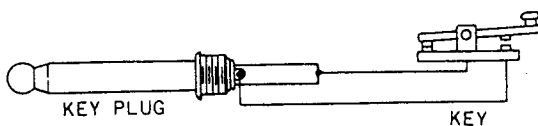

Key plug connection



Headphone and external speaker connections

INSTALLATION

ANTENNA CONSIDERATIONS

For full transmitter output power, the antenna system must present a resistive impedance of very close to 50 Ohms. The protective circuitry for the final transistors will automatically reduce the collector current and, hence, the power output, if a high SWR condition exists. If the SWR cannot be kept below 1.5:1 with respect to 50 Ohms an antenna coupler such as the Yaesu FC-301 should be used to secure a 50-Ohm load impedance for the FT-7.

When the SWR is 1.0:1, 100% output power is produced. With a 1.5:1 SWR, 80% output power is produced. At 2.0:1 the power is reduced to 50%, and at 3.0:1 it is 20% of the full rated output.

The YAESU RS- series of mobile antennas is designed for use with the FT-7. The RSM-2 and the RSE-2 element form the foundation for the system, and the RSL-3.5-28 whip resonators are utilized to provide HF band coverage. For two meter band coverage, the RSL-whip may be removed and the RSE-2 used as a two-meter antenna.







IMPORTANT NOTE

BEFORE ATTEMPTING OPERATION OF YOUR FT-7, PLEASE READ THE FOLLOWING SECTIONS DEALING WITH POWER CONNECTIONS AND TUNE-UP CAREFULLY. WHILE THE FT-7 IS EXTREMELY STRAIGHT-FORWARD AS TO ITS OPERATION, THE OPERATOR MAY BE UN-FAMILIAR WITH THE FUNCTIONS OF SOME OF THE CONTROLS, AND THE FOLLOWING SECTIONS SHOULD MAKE THEM CLEAR.

POWER SOURCES

The FT-7 is designed to operate from a 13.5-VDC power source capable of supplying 6 Amps continuous current. For mobile use, connect the power cord red lead to the positive battery terminal, and the black lead to the negative (ground) side.

For operation from 117 VAC, use the FP-7 or FP-4 power supply. If it is desired to use the FL-110 100-watt amplifier, the FP-301D or FP-301 power supply may be used to supply power for both the FT-7 and the FL-110.

RSL3.5 - 
RSL7A - 
RSL14 - 
RSL21 - 
RSL28 - 
 ★ RSE-2

For Service Manuals Contact
MAURITRON TECHNICAL SERVICES
8 Cherry Tree Rd, Chinnor
Oxon OX9 4QY
Tel:- 01844-351694 Fax:- 01844-352554
Email:- enquiries@mauritron.co.uk



★ RSM-2

ADVANCE PREPARATION

Before power is applied, the operator should read this manual carefully, and should inspect the transceiver to become familiar with the locations of all the switches and controls.

- (1) When initial tune-up is attempted, it is very desirable that a dummy load of 50 Ohm impedance be used, so as to prevent any confusion created by reduced power output because of high SWR. When an antenna is connected to the rear panel receptacle, it should be pre-tuned in advance with a different transmitter, so as not to damage the FT-7 output transistors with extremely high SWR.
- (2) A standard low impedance (500-600 Ohm) microphone should be connected to the microphone receptacle on the front panel.
- (3) For CW operation, a key should be connected to the jack on the rear panel.

MAIN TUNING DIAL FREQUENCY READOUT

- (1) Coarse frequency determination is made by referring to the lower of the two analog dials. The lower one has numerical calibrations every 100 kHz and a calibration mark every 50 kHz. The upper dial has numerical calibrations every 10 kHz, with resolution marks to 1 kHz.
- (2) Frequency readout on all bands is determined by adding the frequency on the main tuning dial to the frequency of the lower band edge. For 40m, 20m, 15m, and 10m band segments A and C, the band edge begins at 000 (for example 7000 kHz on 40 m). On 80m and 10m band segments B and D, the lower band edge begins with 500 (for example, 28500 kHz on 10m B). Thus, a reading of 074 on the main tuning dial will represent 3574 kHz, 7074 kHz, 21074 kHz, 28074 kHz, 28574 kHz, 29074 kHz, or 29574 kHz, depending on the position of the band switch.

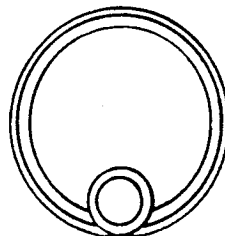
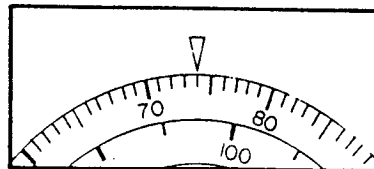

OPERATING INSTRUCTIONS

With the POWER switch in the OFF position, connect the power cord to the 6-pin POWER receptacle on the rear panel of the FT-7.

- (1) For SSB operation, LSB is used on the 3.5 and 7 MHz bands, while USB is standard on 14, 21, and 28 MHz. Preset the controls as follows:

MODE: Desired mode
NB/MARK: OFF
VFO/FIX/CLAR: VFO
DIAL: Desired frequency
TUNE: 12 o'clock position
BAND: Desired Band
AF GAIN: Fully counter-clockwise
RF GAIN: Fully clockwise

For Service Manuals Contact
MAURITRON TECHNICAL SERVICES
8 Cherry Tree Rd, Chinnor
Oxon OX9 4QY
Tel: 01844-351694 Fax: 01844-352554
Email: enquiries@mauratron.co.uk

- (2) Flip the FT-7 POWER switch to ON. If using AC power, flip the FP-7 or FP-4 power switch to ON. The FT-7 dial light should be illuminated with the power on.
- (3) Adjust the AF GAIN control for a comfortable listening level.
- (4) Vary the TUNE control for maximum receiver background noise.
- (5) Rotate the DIAL as needed to tune in the desired frequency.
- (6) If a large excursion is made with the DIAL, the TUNE control may require readjustment. Also, the AF GAIN control will require adjustment to maintain a comfortable listening level.
- (7) The VFO/FIX/CLAR switch may be placed in the CLAR position to vary the receive frequency \pm 2 kHz without changing the transmit frequency.
- (8) The NB/MARK control may be placed in the NB position to minimize interference due to noise.

TUNE-UP

- (1) The initial tune-up procedure for CW and SSB is the same for both modes. Preset the controls as follows:

MODE: CW
DIAL: Desired frequency
TUNE: Peaked as per preceding section
BAND: Desired band

With the MODE switch in the CW position and no plug inserted in the KEY jack, the transmitter may be placed in the "key down" position for tuning by simply closing the microphone PTT button.

- (2) Turn the POWER switch to ON. If on AC power, turn FP-4 /FP-7 power switch to ON.
- (3) Press the microphone PTT switch to activate the transmitter.
- (4) Rotate the TUNE control for maximum meter reading.
- (5) Release the microphone PTT button to return to the receive condition.

SSB OPERATION

- (1) Following the initial tune-up described above, place the MODE switch in the USB or LSB position as appropriate for the band in use.
- (2) Press the microphone PTT button and speak into the microphone in a normal voice. Advance the MIC GAIN control until the meter indicates 1/2 to 2/3 the level observed while tuning in the CW position.
- (3) Release the microphone PTT switch. You are now tuned up for SSB operation.
- (4) The MIC GAIN control should never be advanced more than necessary to achieve the 1/2 to 2/3 scale deflection, excessive mic gain may cause distortion of the output signal.

CW OPERATION

- 1) Plug a key into the KEY jack on the rear panel. CAUTION: when using an electronic keyer, the operator should be sure that the keyer output transistor or relay is rated for the current and voltage present at the key jack. The key line is +8V at 300 uA key down current.
- 2) Set the MODE switch to CW
- 3) Automatic CW semi-break-in is utilized in the FT-7. When the key is closed, the transmitter is automatically activated, and when the key is opened, the transceiver returns to the receive condition after a slight delay. The length of the time delay can be varied to suit the operator by adjustment of VR702.
- 4) In the key down condition, the IC meter should indicate "3", while it should read "0" while in the transmit condition but "key up".

- 5) To ensure accurate keying, a sidetone monitor is built in. When the transmitter is keyed, this sidetone will be heard on the speaker. The sidetone volume level may be adjusted by varying VR701.
- 6) When the keying speed is very slow, the keying relay in the transceiver may return to receive in the middle of a letter or word. If this is the case, it may be to the advantage of the operator to use the PTT switch to activate the transmitter.

For Service Manuals Contact
MAURITRON TECHNICAL SERVICES
8 Cherry Tree Rd, Chinnor
Oxon OX9 4QY
Tel: 01844-351694 Fax: 01844-352554
Email: enquiries@maurtron.co.uk

DIAL CALIBRATION

- 1) Set the NB/MARK switch to MARK and VFO/FIX switch to VFO position.
- 2) Set the main tuning dial to the 100 kHz position nearest the desired operating frequency.
- 3) Adjust the lever underneath the main tuning knob for zero beat against the marker signal.

FIX (CRYSTAL CONTROLLED) OPERATION

Fixed channel operation is possible by using crystals installed in the FIX UNIT. The VFO/FIX switch must be placed in the FIX position. There is only one crystal controlled channel available per band with the FT-7.

Crystals used in the FT-7 must meet the specifications shown in Fig. 2, and they are available through your Yaesu dealer. Crystal frequencies must fall between 5500-5000 kHz. Frequency calculation is made from the formula $F_x = F_1 - F_0$, where F_x is the crystal frequency, F_0 is the desired operating frequency, and F_1 is a constant derived from Fig. 1.

For example, let us say that it is desired to operate on 7199 kHz LSB. Referring to Fig. 1, we see that for 40-meter LSB, F_1 is 12501.5. Subtract F_0 (7199 kHz) from F_1 (12501.5) to equal 5302.5 kHz (F_x). For example, let us say it is desired to operate on 21420 kHz USB. From Fig. 1, F_1 is 26498.5; subtract 21420 from 26498.5 to equal F_x of 5078.5 kHz.

Inspection of the values of F_1 in Fig. 1 will reveal that the 7199 kHz crystal for LSB will work on 14199 kHz, 21199 kHz, etc. Of course, LSB is not normally used on these bands. If the operator switches to USB, the operating frequency (in this case 7199, 14199, etc.) will be moved 3 kHz down to 7196, 14196, etc. If the move is made from LSB to CW, the frequency moves down 800 Hz (to 7198.2, 14198.2, etc.) except on 80 meters, where the shift is 1.2 kHz down.

MODE BAND	U S B	L S B	CW
80m	8998.5	9001.5	8999.3
40m	12498.5	12501.5	12500.7
20m	19498.5	19501.5	19500.7
15m	26498.5	26501.5	26500.7
10mA	33498.5	33501.5	33500.7
10mB	33998.5	34001.5	34000.7
10mC	34498.5	34501.5	34500.7
10mD	34998.5	35001.5	35000.7

Figure 1 (kHz)

Type	HC-25/U
Load Capacitance	30pF
Series Resistance	25 Ohms or less
Static Capacitance	7pF or less
Drive Level	5mW

Figure 2

CIRCUIT DESCRIPTION

The FT-7 transceiver utilizes plug-in modules for the most efficient use of space and to simplify the trouble-shooting and repair process. The transceiver is all solid-state, and the receiver and transmitter operate in a single-conversion configuration utilizing a premix heterodyne technique which greatly reduces signal distortion in both the transmit and receive modes.

RECEIVER

The incoming signal from the antenna is fed through the antenna relay RL2102, (normally open) band switch S1901, and the tuning circuit consisting of T1921-T1925 and VC1901 to pin 9 of the RF/MARK unit PB-1633. The signal is then fed to gate 1 of the RF amplifier Q104 (3SK40M), a dual-gate MOS FET. The AGC (Automatic Gain Control) voltage is applied to gate 2 of Q104 to control the gain of this stage, to avoid overloading in the following stages.

The amplified signal is fed through the passband tuning circuit to the mixer unit PB-1631. The buffer amplifier Q201 (2SC535A) is used to accomplish impedance matching between the RF amplifier and the diode mixer consisting of D203-D206 (all 1SS16), where the incoming signal is mixed with the signal from the premix circuit. Schottky barrier diodes are used for the mixer to secure high dynamic range with low noise.

The mixer produces a 9 MHz IF signal at the output of T201. The IF signal is fed through a low-pass filter consisting of L201, C202, C201, and a diode switch D201 (1S1555), to the FILTER unit P3-1626.

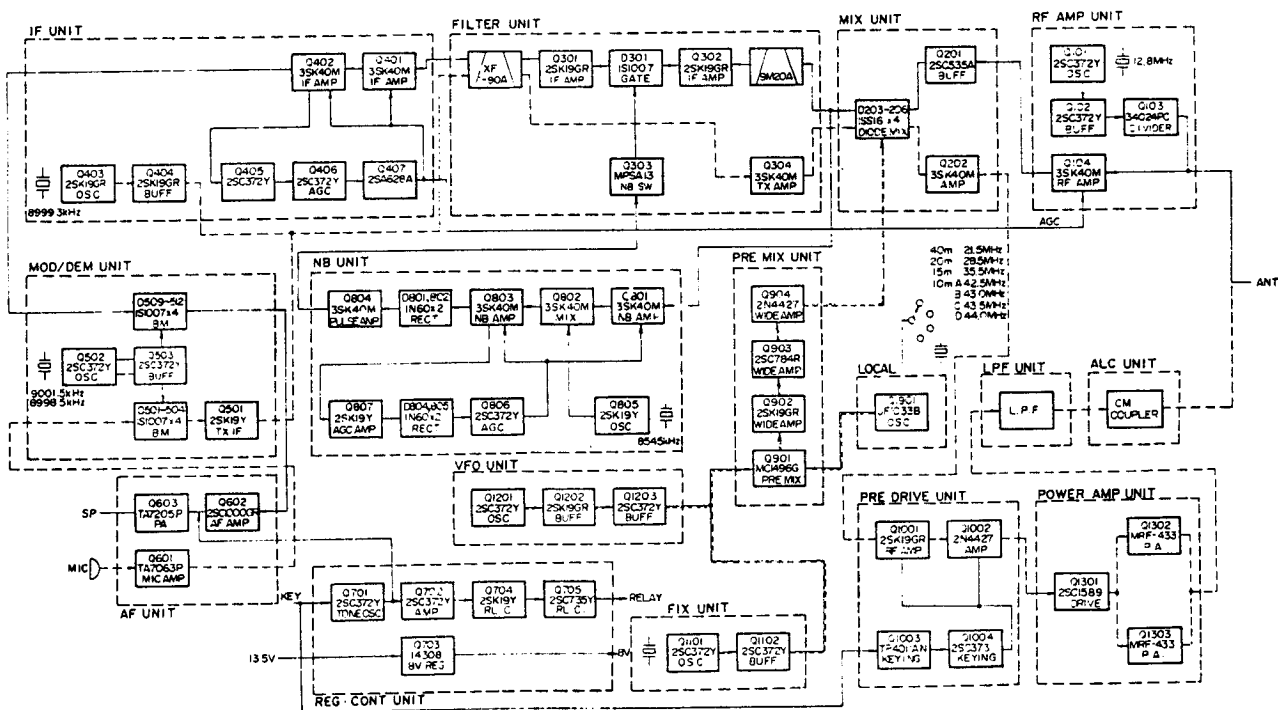

FT-7
BLOCK DIAGRAM

For Service Manuals Contact
MAURITRON TECHNICAL SERVICES
 8 Cherry Tree Rd, Chinnor
 Oxon OX9 4QY
 Tel: 01844-351694 Fax: 01844-352554
 Email: enquiries@mauritron.co.uk

The IF signal is passed through a monolithic filter X301 and is amplified by IF amplifiers Q301 and Q302 (both 2SK19GR). A noise blanker diode D301 (1S1007) is controlled by Q303 (MPSA13) to cut impulse noise.

The output from Q302 passes through an 8-pole crystal filter and a diode switch D303 (1N60), and is fed to the IF unit PB-1625. The signal is further amplified by Q401 and Q402 (both 3SK40M). The amplified signal is fed to the ring demodulator consisting of D509-D512 (all 1S1007). The carrier signal is also fed to the ring demodulator from the buffer amplifier Q503.

Audio output from the ring demodulator is fed to the AF unit PB1648 and is amplified by Q602 (2SC1000GR) and Q613 (TA7205P), to deliver 3 watts of audio signal to the speaker.

A part of the IF signal is fed to pin 2 of NB unit PB-1627. When the NB/MARK switch is placed in the NB position, the signal is amplified by Q801 (3SK40M) and fed to the gate of noise blanker mixer Q802 (3SK40M), where the 8545 kHz signal generated by Q805 (2SK19Y) is mixed with the incoming IF signal to produce a 455 kHz signal is then amplified by Q803 (3SK40M).

When a carrier or noise-free modulated signal is received, the 455 kHz signal with its corresponding strength is rectified by D 801 and D802 (both 1N60) to charge C813. There is no discharge loop for C813; therefore, a signal which exceeds the charged voltage established by the reference voltage on C813 will not pass through D801 and D802. Accordingly, there will be no voltage drop across R819, and Q804 (3SK40M) will conduct as the gate voltage approaches zero, causing the drain voltage to drop.

The drain of Q804 is connected directly to the base of noise gate controller Q303 (MPSA13) in the FILTER unit. The voltage drop of the drain will turn off Q303, causing a forward bias to D301. As D301 conducts, the signal will pass through the circuit.

When impulse-type noise which exceeds the charged reference level voltage on C813 is received, D801 and D802 will permit negative-going pulses to turn off Q804. Thus, Q303 will conduct. As a result, D301 will be biased to block the signal passage.

The signal amplified by Q807 (2SK19GR) is rectified by D804 and D805 (both 1N60). The rectified DC voltage is amplified by DC amplifier Q806 (2SC372Y) and fed to the gate of Q801 and Q803 to control the gain of these stages.

The crystal-controlled marker generator Q101 (2SC372Y), located on the RF/MARK unit, generates a basic 12.8 MHz signal. The 12.8 MHz signal is fed through a buffer amplifier Q102 (2SC372Y) to a frequency divider Q103 (34024PC) to produce the 100 kHz marker signal. The 100 kHz marker signal is fed through pin 4 and pin 9 to the receiver front end.

TRANSMITTER

Speech input from the microphone jack J2108 is fed through the MIC GAIN control VR2103 to pin 2 of the AF unit PB-1648. The speech signal is amplified by Q601 (TA7063P), then fed to the ring modulator D501-D504 (all 1S1007) in MOD/DEM unit PB-1624. The resulting 9 MHz DSB signal is amplified by Q501 (2SK19Y) and fed through a diode switch D505 (1S1555) to the FILTER unit.

The signal is amplified by a buffer, Q302 (2SK19GR), and fed to the crystal filter X302 where the unwanted sideband is rejected. The 9 MHz SSB signal generated by the filter is fed through diode switch D302 (1N60) to Q304 (3SK40M), and its output signal is fed to pin 4 of MIX unit PB-1631. The 9 MHz SSB signal is heterodyned to the desired RF frequency by injection of the local signal which is supplied from the PRE MIX unit PB1630A.

The RF output from the diode mixer is amplified by Q202 (3SK40M) and fed through diode switch D208 (1S1555) and bandpass transformers T1906-T1911 to PRE DRIVE unit PB-1632. Transformers T1906-T1911 are used on both transmit and receive to provide unsurpassed selectivity. The RF signal is amplified by Q1001 (2SK19GR) and Q1002 (2N4427) and fed to the 10W AMP unit PB-1443. The output from the PRE DRIVE unit is amplified by the driver Q1301 (2SC1589) to drive the push-pull power amplifier consisting of Q1302 and Q1303 (both MRF 433), which produces a nominal power output of 10 watts.

A nonresonant, broadband power amplifier such as the one used in the FT-7, utilizing ferrites and the most advanced circuitry, eliminates the nuisance of having to tune up when changing bands.

The negative feedback circuitry, which consists of R1310, R1311, C1113, and C1114, stabilizes the final amplifier and delivers a clean signal to the output circuitry. Zener diode D1301 (YZ033) sets the bias for Q1301-Q1303 at exactly 3V.

Silicon diodes D1302 and D1303 (10D10) are mounted on Q1302 and Q1303, respectively, to compensate bias, as well as to protect them from thermal runaway.

The band switch S2102 selects the proper low-pass filter network for the band in use. The signal passes through T1501 in the ALC unit PB-1637 and the antenna relay RL 2102 to the antenna terminal J2101. T1501 detects the forward and reflected waves; the forward wave is rectified by D1502 (1S1007), and the reflected wave by D1504 (1S1007), to generate ALC voltage. The ALC threshold level of the forward wave is set by VR1501.

When there is an excessive amount of reflected power due to high SWR, the reflected wave is rectified by D1503 (1S1007) producing minus voltage to the ALC line. The ALC voltage reduces the gain of Q304 to prevent overloading or distortion.

For CW transmission, the crystal oscillator Q403 (2SK19GR) in the IF unit oscillates at 8999.3 kHz (the carrier frequency). This CW carrier is amplified by Q404 (2SK19GR) and fed through pin 5 to Q302 in the FILTER unit.

In the CW mode, the emitter voltage of Q1001 and Q1002 is controlled by the keying switch transistor Q1004 (2SC373). A flip-flop circuit utilizing Q1003 (MC14011B) is employed to secure a perfectly-shaped waveform for CW transmission free of clicks at any keying speed.

The tone oscillator Q701 (2SC373) operates when the MODE switch is in the CW position. It consists of a phase-shift oscillator operating at approximately 800 Hz. The tone output is activated by the keying circuit and is coupled to Q702 (2SC372Y) for semi-break in CW operation. The relay delay hold time is adjusted by VR702. The output is also fed to Q603 (TA7205P) through level set potentiometer VR701 for CW sidetone monitoring.

COMMON CIRCUITS

The carrier oscillator Q502 (2SC3724) is followed by a buffer amplifier Q503 (2SC372Y). It oscillates at either 8998.5 kHz (40-10 meters LSB, 80 meters USB) with X901 or 9001.5 kHz (40-10 meters USB, 80 meters LSB) with X902 depending on the mode of operation. The crystal selection is made by diode switches D507 and D508 (1S1555). The carrier is then fed through a relay RL501 to the ring modulator and demodulator.

The LSB crystal is used for CW reception on all bands. For CW transmission, the oscillator in the IF unit oscillates with X401.

A modified Colpitts type oscillator is used to generate a 5.0-5.5 MHz signal to produce a stable 500 kHz tuning range. The frequency is varied by VC1201, which is geared to a precision-built dial tuning mechanism.

The varactor diode D1201 (1S2236) is in series with C1207, and the combination is in parallel with VC1201. By closing the clarifier switch, the clarifier control shifts the receiver ± 3 kHz.

The VFO output signal is fed through the amplifier/buffer stage Q1202 (2SK19GR) and Q1203 (2SC372Y), the low-pass filter, and the diode switch D1202 (1S1555) to the PRE MIX unit PB1630.

In addition to normal VFO operation, a crystal-controlled channel may be used. Crystal oscillator Q1101 (2SC372Y) is followed by buffer amplifier Q1102 (2SC372Y), and its output is fed through the low-pass filter and diode switch D1901 (1S1555) to the PRE MIX unit. Trimmer capacitors TC1101-TC1105 are used for fine adjustment of each crystal frequency.

Crystal oscillator Q1901 (JF-1033) produces a heterodyne signal selected by the band switch. The signal is fed to the double balanced mixer Q901 (MC-1496G) in the PRE MIX unit PB-1630, where the signal is mixed with a signal from the VFO. The output from the mixer is fed through bandpass transformers T1902-T1905 to the broadband amplifier Q902 (2SK19GR), Q903 (2SC784R), and Q904 (2N4427). The premix output signal is then applied to the diode mixer in the MIX unit.

40m	X1902	21.5MHz	HC-18/U
20m	X1902	28.5MHz	HC-18/U
15m	X1903	35.5MHz	HC-18/U
10mA	*	42.5MHz	HC-25/U
10mB	X1904	43.0MHz	HC-25/U
10mC	*	43.5MHz	HC-25/U
10mD	*	44.0MHz	HC-25/U

For Service Manuals Contact
MAURITRON TECHNICAL SERVICES
 8 Cherry Tree Rd, Chinnor
 Oxon OX9 4QY
 Tel:- 01844-351694 Fax:- 01844-352554
 Email:- enquiries@mauritron.co.uk

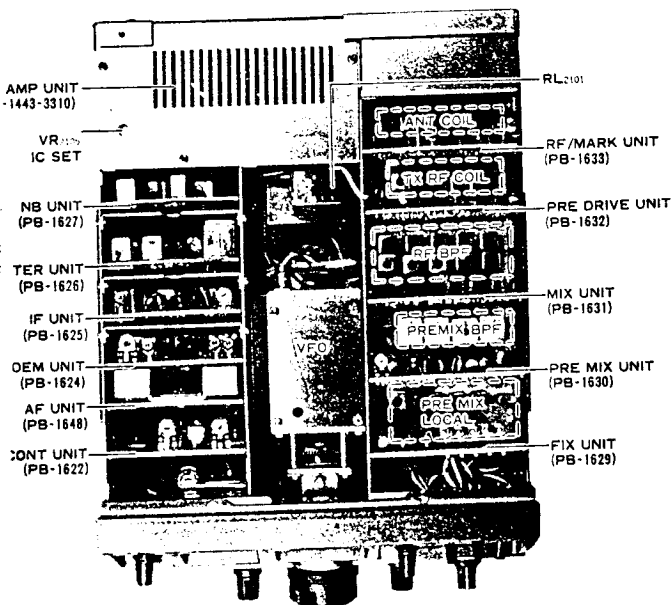

TOP VIEW

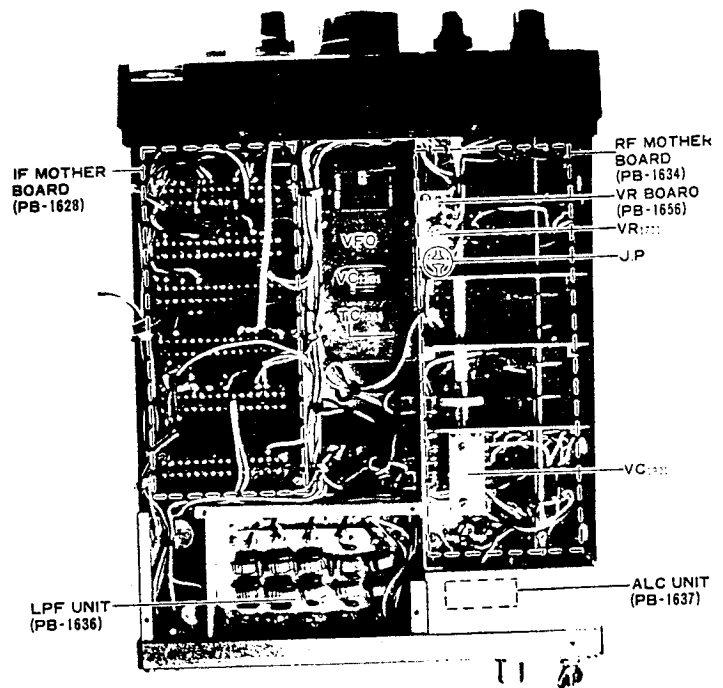

BOTTOM VIEW

MAINTENANCE AND ALIGNMENT

General

This transceiver has been carefully aligned and tested at the factory prior to shipment. The reliability of the solid state devices used in the FT-7 should provide years of trouble-free service if the equipment is not abused and the proper routine maintenance is carried out.

Do not attempt to align the transmitter without having a proper dummy load or antenna connected to the transceiver. We highly recommend off-the-air testing using a dummy load as a courtesy to other operators.

The following alignment procedure requires certain test equipment such as an RF signal generator, an audio oscillator, a sweep generator, an oscilloscope, and a VTVM. Without proper test equipment, do not attempt to adjust cores or potentiometers.

Control Unit (PB-1622)

- (1) CW relay delay adjustment (VR702):
 - (a) Connect a dummy load or matched antenna to the ANT connector. Connect a key to the KEY jack, and place the MODE switch in the CW position.
 - (b) When the key is closed and then opened again, it will be observed that there is a delay between the instant the transceiver returns to "receive!" The length of the delay may be varied by adjustment of VR702, in order to provide the proper delay for the keying speed used and/or the preferences of the individual operator.
- (2) Sidetone level adjustment (VR701)
 - (a) The level of the CW sidetone may be adjusted by varying VR701 while the key is closed.

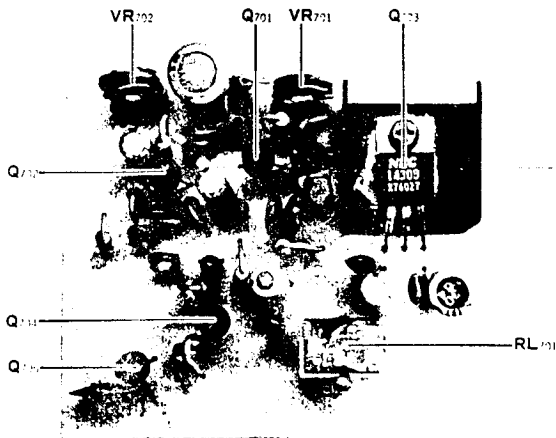

CONT UNIT(PB-1622)

MOD /DEM UNIT (PB-1624)

(1) SSB carrier point (TC502, TC503):

- (a) Settings: BAND.....20
DIAL..... 14.25 MHz
MODE.....CW
Peak the TUNE control to secure maximum output.
- (b) Place the MODE switch in the USB position. Connect the output of an audio oscillator to the microphone input. Set the frequency to 1 kHz and transmit on USB. Adjust the MIC GAIN control for 8 watts RF output to the dummy load.
- (c) Shift the audio frequency to 300 Hz without changing audio output level or MIC GAIN control.
- (d) Switch between USB and LSB while adjusting TC502 for USB and TC503 for LSB to obtain 2 watts output on each sideband. (Note: For the 80 meter band, TC502 will adjust LSB and TC503 will adjust USB, but the alignment here is taking place on 20 meters.
- (e) Return to the receive mode. Switch the MODE selector back and forth between USB and LSB. The tone quality of the background noise on the two sideband modes should sound alike.

(2) CARRIER BALANCE

- (a) Settings: BAND.....20
DIAL.14.25 MHz
MODE.....USB
No input to the mike jack.
- (b) Connect a dummy load to the antenna receptacle and the RF probe of a VTVM to the antenna receptacle, J2101. Adjust TC501 and VR501 alternately to minimize the VTVM reading.
- (c) If no VTVM is available, use a monitor receiver and adjust TC501 and VR501 for the minimum S meter reading.

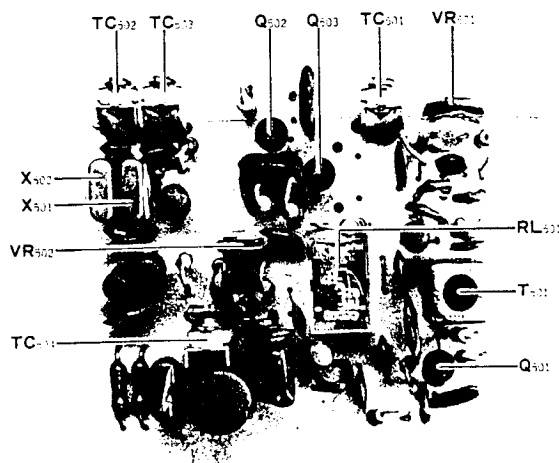

For Service Manuals Contact
MAURITRON TECHNICAL SERVICES
8 Cherry Tree Rd, Chinnor
Oxon OX9 4QY
Tel:- 01844-351694 Fax:- 01844-352554
Email:- enquiries@mauritron.co.uk

MOD/DEM UNIT(PB-1624)

IF UNIT (PB-1625)

(1) CW carrier level adjustment (TC401):

- (a) Connect the RF probe of a VTVM to pin 2 of PB-1625. With the MODE switch in the CW position and the key closed, adjust TC401 for a reading of $75 \text{ mV} \pm 10 \text{ mV}$.

(2) S-meter calibration (VR401):

- (a) Place the band switch to 40 meters and the MODE switch to USB. Connect a signal generator to the antenna receptacle, and set the generator frequency to the receiver frequency.
- (b) Adjust the signal generator output to 87 dB. Adjust VR401 for full scale S-meter deflection.

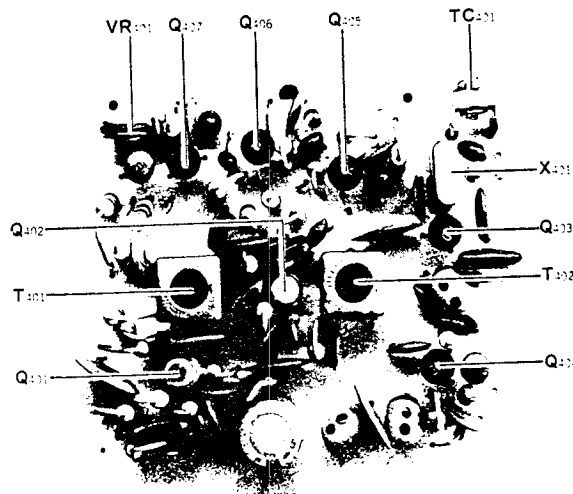

IF UNIT (PB-1625)

LOCAL UNIT

(1) Local oscillator level adjustment (T1901, TC1901-TC1904)

- (a) Connect the RF probe of a VTVM to TP 1901. Place a crystal for the 10mD band (44 MHz) in the socket for the 10 meter band. Adjust the core of T1901 for a reading of 50 mV on the VTVM.
- (b) Place the crystal for the 10mB band (43 MHz) in the 10 meter band crystal socket. Adjust TC1904 for a reading of 50 mV on the VTVM.
- (c) Switch to the 15 meter band. Adjust TC1903 for a reading of 50 mV on the VTVM.
- (d) Switch to the 20 meter band. Adjust TC1902 for a reading of 50 mV on the VTVM.
- (e) Switch to the 40 meter band. Adjust TC1901 for a reading of 50 mV on the VTVM.

(2) Premix bandpass filter adjustment (T1902-T1905):

The adjustment of the bandpass filters is critical with respect to spurious response. A sweep generator and a scope are required for proper alignment.

- (a) Locate PB-1656, which can be found on the bottom side of the RF mother board (see photo on page). Locate JP on PB-1656. For this alignment, remove the solder on the shorting device, breaking the connection.
- (b) Connect the output of a sweep generator to TP1901 and the RF probe of a scope to TP1902. Monitor the wave patterns on the scope by offsetting the balancing potentiometer VR901 on the PREMIX unit.
- (c) Set the VFO/FIX switch to FIX to disconnect the VFO from the circuit. Apply 30 dB sweep output to TP1901.
- (d) Adjust the bandpass filter transformer cores as follows, so that the passband characteristics become as flat as possible within the passband range specified, and maximum attenuation out of range.

<u>BAND</u>	<u>PASSBAND</u>	<u>CORE ADJUSTMENT</u>
40	16.0-16.5 MHz	T1902
20	23.0-23.5 MHz	T1903
15	30.0-30.5 MHz	T1904
10	37.0-37.5 MHz	T1905

For Service Manuals Contact
MAURITRON TECHNICAL SERVICES
8 Cherry Tree Rd, Chinnor
Oxon OX9 4QY
Tel: 01844-351694 Fax: 01844-352554
Email: enquiries@mauritron.co.uk

PREMIX UNIT (PB-1630)

- (1) Premix balance (VR901):
Connect the RF probe of a VTVM to TP1902. Place the VFO/FIX switch in the FIX position. Adjust VR901 for a minimum reading on the VTVM.

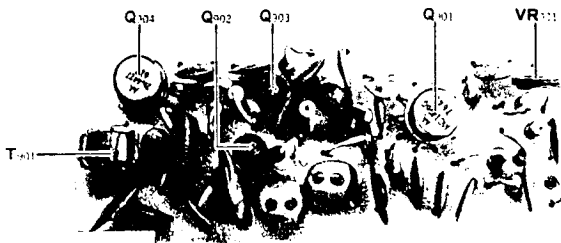

PRE MIX UNIT(PB-1630)

Transmit/receive frequency band-pass filter adjustment (T1906-T1915):

- (a) Connect the output of the sweep generator to the antenna receptacle, and the scope input to the emitter of Q201 on the MIX unit. Remove the IF unit, and cut off the AGC voltage. Connect a jumper between pin 10 and pin 11 of the RF unit, and connect a 100 Ohm resistor between pin 8 and pin 9 of the RF unit to reduce the input Q of the circuit.

(b) Adjust the transformer cores as follows, to secure the most flat response possible over the passband indicated:

80m Band	3.5MHz ~ 4.0MHz	(T ₁₉₀₆ , T ₁₉₀₇)
40m Band	7.0MHz ~ 7.5MHz	(T ₁₉₀₈ , T ₁₉₀₉)
20m Band	14.0MHz ~ 14.5MHz	(T ₁₉₁₀ , T ₁₉₁₁)
15m Band	21.0MHz ~ 21.5MHz	(T ₁₉₁₂ , T ₁₉₁₃)
10m Band	28.0MHz ~ 30.0MHz	(T ₁₉₁₄ , T ₁₉₁₅)

(c) After making the necessary adjustments, return the circuitry to its original condition: remove the 100 Ohm resistor and jumper from the RF unit, restore the AGC voltage, and replace the IF unit.

For Service Manuals Contact
MAURITRON TECHNICAL SERVICES
 8 Cherry Tree Rd, Chinnor
 Oxon OX9 4QY
 Tel: 01844-351694 Fax: 01844-352554
 Email: enquiries@mauritron.co.uk

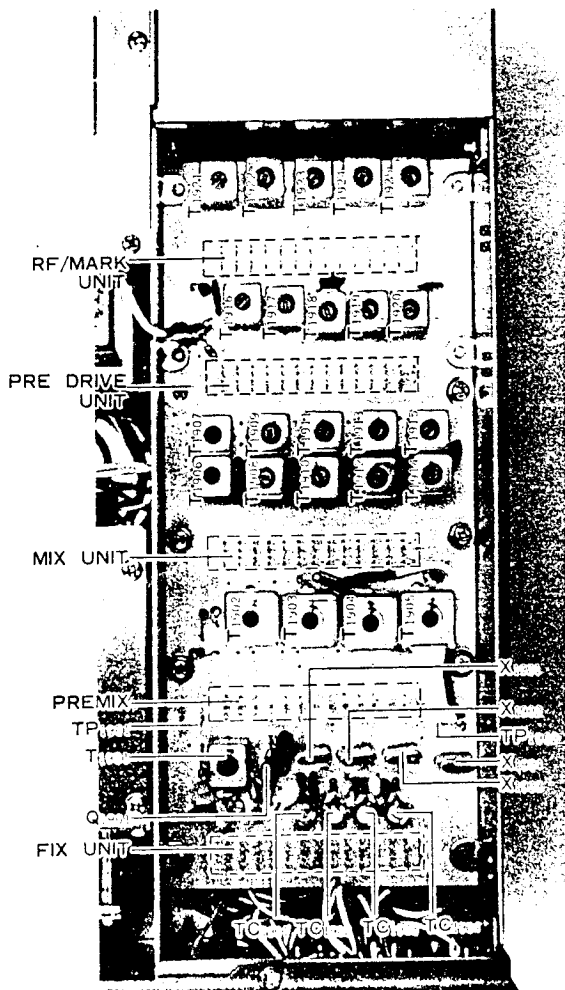

(3) VFO unit (PB-1440A-3310) Skilled technique is required as well as advanced knowledge to align the VFO unit. It is, therefore, recommended that all VFO work be referred to qualified personnel should a case develop where a repair is needed on the VFO unit.

TC1201: Band setting trimmer capacitor.

TC1202: A split-type trimmer capacitor for temperature compensation.

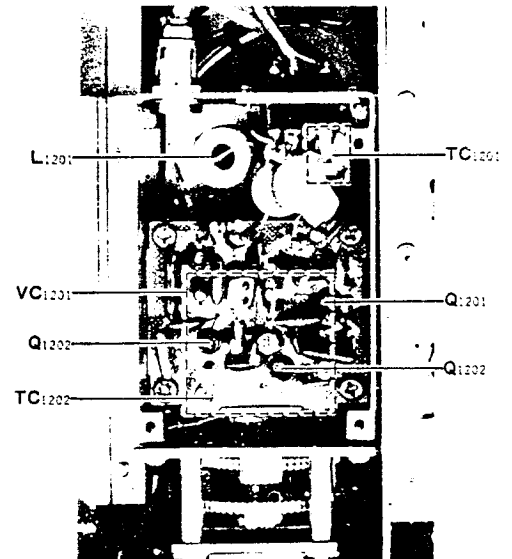

(4) It is possible to use one crystal controlled channel per band with the FT-7. The crystal should be inserted in the socket appropriate for the band to be used, and TC1101, 1102, 1103, 1104, and 1105 provide fine frequency tuning for the 80, 40, 20, 15, and 10 meter bands, respectively.

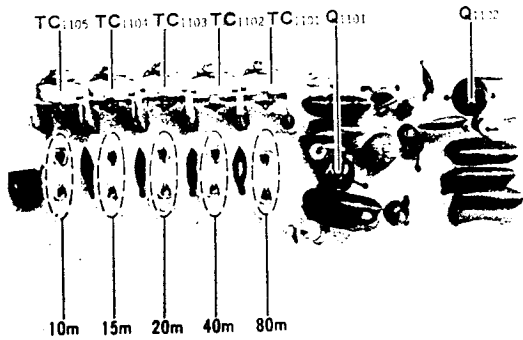

FIX UNIT(PB-1629)

- (5) Clarifier zero setting (VR1701):
- (a) Tune the transceiver to the marker or a signal generator on any band.
 - (b) Set the CLAR control to the 12 o'clock position. Turn on the CLAR switch, and tune the main dial for a zero beat to the marker or signal generator.
 - (c) Now turn the CLAR switch to VFO, and if the tone of the marker or signal generator is changed (away from zero beat) secure zero beat by adjusting VR1701.
 - (d) Replace the solder bridge on shorting device JP on PB-1656.
 - (6) RF tracking (T1916-T1925)

- (a) Connect a dummy load or matched antenna to the antenna receptacle on the rear panel. Set the transceiver controls as follows:

MODE.....CW
 DIAL.....250
 TUNE...Center scale ("5")

- (b) Set the band switch to 80. While transmitting, adjust T1916 for maximum power output into the dummy load.

- (c) Repeat this procedure on each band, adjusting the transformers appropriate for the bands selected:

<u>BAND</u>	<u>CORE ADJUSTMENT</u>
40	T1917
20	T1918
15	T1919
10	T1920

- (d) Remove the dummy load from the antenna receptacle and connect a signal generator to the antenna receptacle. While receiving, zero the signal generator output to the frequency to be adjusted (3750, 7250, etc.) and adjust the transformer cores below for maximum deflection of the S-meter:

<u>BAND</u>	<u>CORE ADJUSTMENT</u>
80	T1921
40	T1922
20	T1923
15	T1924
10	T1925

(e) Other coils:

<u>UNIT</u>	<u>COIL</u>	<u>PROCEDURE</u>
FILTER	T-301-	Peak to 9MHz on receive
	T-304	
	T305	Peak to 9MHz on transmit
IF	T401, T402	Peak to 9MHz on receive
MOD/ DEM	T501	Peak to 9MHz on transmit
NB	T801	Peak to 9MHz on receive, NB ON
	T802, T803	Peak to 455 kHz on receive, NB ON
	T804	Peak to 8545 kHz on receive, NB ON

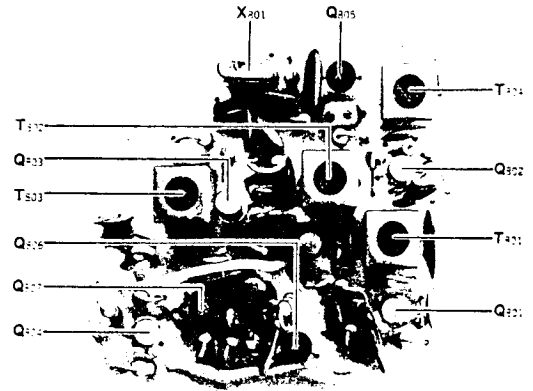

NB UNIT(PB-1627)

For Service Manuals Contact
MAURITRON TECHNICAL SERVICES
 8 Cherry Tree Rd, Chinnor
 Oxon OX9 4QY
 Tel: 01844-351894 Fax: 01844-352554
 Email: enquiries@mauritron.co.uk

ALC UNIT (PB-1637)

- (a) Connect a dummy load to the antenna receptacle. Set VR1501 to the fully clockwise position. Peak the transmitter for maximum power output on 10 meters, CW mode. Adjust TC1501 for maximum power output to the dummy load.
- (b) Peak the transmitter for maximum output on 80 meters, CW mode. Slowly rotate VR1501 until the output power just starts to fall.
- (c) Care must be exercised when adjusting VR1501 using other than a 50 Ohm resistive dummy load; a high SWR condition on the transmission line will cause an improper setting of VR1501.

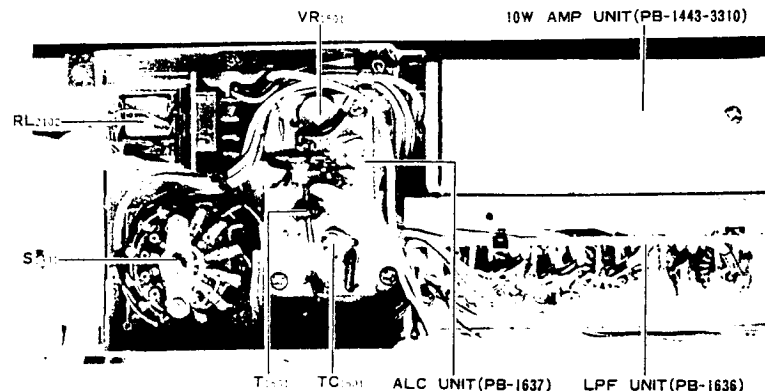

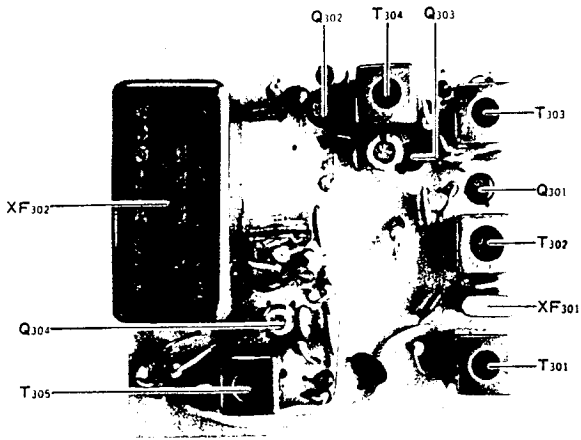

FILTER UNIT(PB-1626)

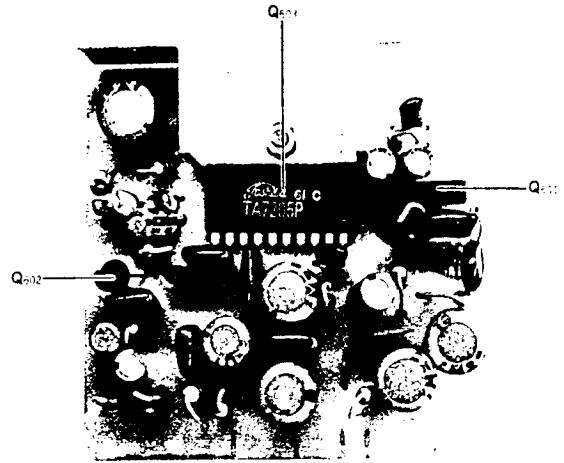

AF UNIT(PB-1648)

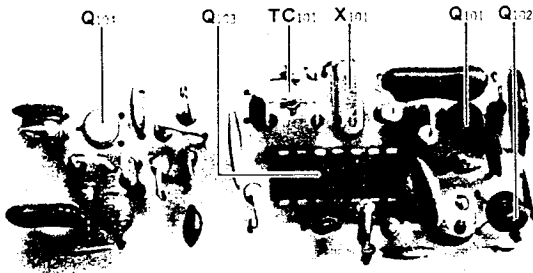

RF/MARK UNIT(PB-1633)

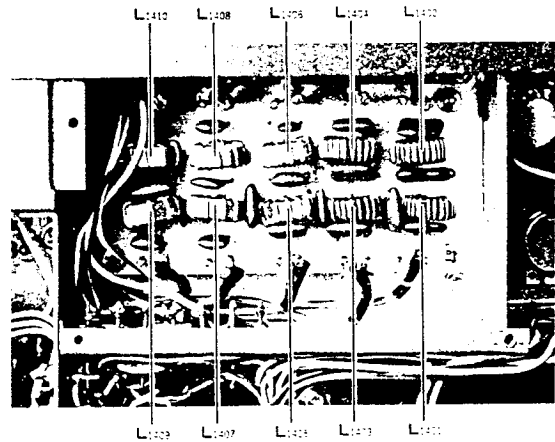

LPF UNIT(PB-1636)

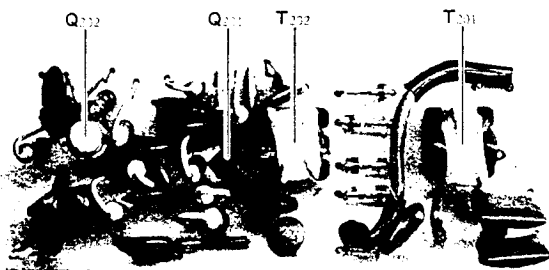

MIX UNIT(PB-1631)

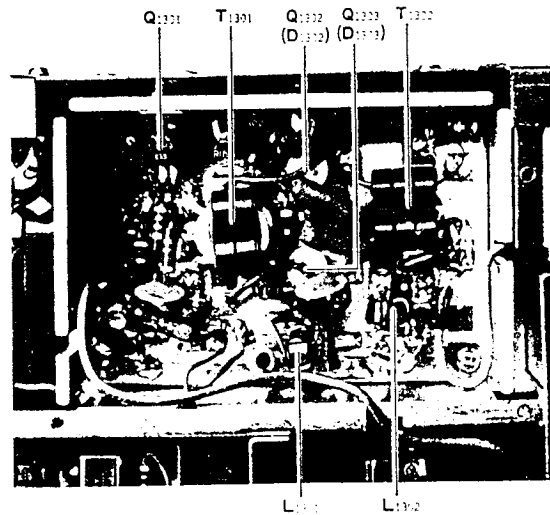

10W AMP UNIT(PB-1443-3310)

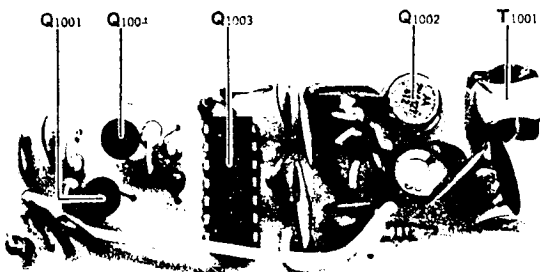

PRE DRIVE UNIT(PB-1632)

PARTS LIST

MAIN CHASSIS			J2106	68060004	QMS-AB6M
Symbol Number	Parts No.	Description			
		DIODE			
D2101, D2103~2105	21015550	Silicon Diode 1S1555	FH2101	69000007	FUSE HOLDER F3265
D2102	21090130	" " U05B			
					FUSE LAMP
		RESISTOR	PL2101	14000027	14V BF311-04071A
R2105	40143561	Carbon Film ¼ VJ 560Ω			
R2104	40143332	" " " " 3.3KΩ			
R2101	42124100	" Composition ½ GK 10Ω			TERMINAL BOARD
R2102	42124101	" " " " 100Ω	TB2103	90030001	1L4P 3-0-1
R2106	42124220	" " " " 22Ω	TB2102	90030002	1L5P 3-0-2
R2107, 2108	42124470	" " " " 47Ω	TB2101	92000002	1L3P 1-0-2
				96000103	Speaker Cord #240030-1
		POTENTIOMETER			
VR2105	49800066	EVHBOAR 10B13 1KΩB			
VR2101	49800094	EVKA2AR 15313 5KB/1KB			
VR2102	49800095	EVHBOAK 30B54 50KB			
VR2103	49800096	EVHBOAK 30B14 10KB			
VR2104	49800097	EVAL04DA AB54 50KB			
					SW BOARD
			Symbol Number	Parts No.	Description
			PB-1635	60416350	Printed Circuit Board
				016350AZ	PCB with Components
		CAPACITOR			
C2104, 2123, C2124	30820103	Ceramic 50WV 0.01μF	R1601	40183223	RESISTOR Carbon Film 1/8W VJ 2.2KΩ
C2101~2103, C2105, 2106	30820473	" " 0.047μF			
C2108~2122	32821102	Ceramic Feed Thru ECK-Y1H			SWITCH
C2107	35220108	Electrolytic 16WV 1000μF	S1602	64000101	Lever Switch SLE62301
			S1601, 1603	64000102	" " SLE64301
		METER		91100008	Wrapping Terminal C
M2101 (R2103)	74000360	AP-140 (with Shunt Resistor)			
		SPEAKER			
SP2101	76000019	SA-92 4Ω 3W			
					RESISTOR BOARD
			Symbol Number	Parts No.	Description
			PB-1656	60416560	Printed Circuit Board
				016560AZ	PCB with Components
		RELAY			
RLS2102	70000002	MX-2P			
RSL2101	70000013	AE3244			
					RESISTOR
			R1704	40143392	Carbon Film ¼W VJ 3.9KΩ
			R1703	40143103	" " " 10KΩ
			R1702	40143183	" " " 18KΩ
			R1701	40143333	" " " 33KΩ
		RELAY SOCKET			
RLS2102	69000003	PX-08			
RLS2101	69000006	AE3840			
					POTENTIOMETER
		SWITCH	VR1701	49905473	SR-19R 47KB
S2101	64000052	8H2011			
S2102 (a) (b)	61000480	BS 2-4-5 (a) (b)		91100008	Wrapping Terminal C
					PLUG
P2102	67020007	SQ4052			
P2103	67030004	CN3965P			
					LAMP BOARD
			Symbol Number	Parts No.	Description
			PB-1665A	60416651	Printed Circuit Board
				016651AZ	PCB with Components
		CONNECTOR			
J2101	68000011	MBR-06D			
J2102~2104	68020013	SG-8018			LAMP
J2108	68040003	FM144S	PL1801~1804	14000015	BQ041-32404A 12V 40mA
J2105	68050003	D5-701B-00			

For Service Manuals Contact
MAURITRON TECHNICAL SERVICES
 8 Cherry Tree Rd, Chinnor
 Oxon OX9 4QY
 Tel: 01844-351694 Fax: 01844-352554
 Email: enquiries@mauritron.co.uk

		RESISTOR					CAPACITOR	
R112	40143330	Carbon Film	¼W VJ	33Ω	C203, 206, 207,	30820103	Ceramic	50WV 0.01μF
R107	40143101	"	"	100Ω	C209~C212			
R108	40143151	"	"	150Ω	C213	33824050	Dipped Mica	5pF
R103, 105	40143102	"	"	1KΩ	C204, 205, 208	33824101	"	100PF
R109	40143182	"	"	1.8KΩ	C201, 202	33824241	"	240PF
R101	40143103			10KΩ				
R102	40143223			22KΩ				
R111, 113, 114	40143104			100KΩ				
R110	40143154			150KΩ	L202, 203	53020001	Micro Inductor	1mH
R104	40143224			220KΩ	L201	53020012	"	1.2μH
R106	40143105			1MΩ				
INDUCTOR								
TRANSFORMER								
CAPACITOR					T201	55003232		#220278
C108	31829100	Ceramic	50WV SL	10PF	T202	55003233		#220277
C104	31820221	"	"	CH 220PF				
C105~C107, C112, 113, 115	30820103	"	"	0.01μF				
C103, 109	30820473	"	"	0.047μF				
C101, 114	33824230	Dipped Mica	"	22PF				
C110	33824101	"	"	100PF	FILTER UNIT			
C102	33824221	"	"	220PF	Symbol Number	Parts No.	Description	
					PB-1626A	60416261	Printed Circuit Board	
						016261AZ	PCB wth Components	
TRIMMER CAPACITOR								
TC101	39000007	ECVIZW	20x40		FET & TRANSISTOR			
					Q301, 302	22800195	FET	2SK19GR
					Q304	23800401	"	3SK40M
INDUCTOR								
L101	53010003	Micro Inductor		250μH	Q303	22390001	Transistor	MPSA13
L102	53020001	"	"	1mH				
DIODE								
					D301	21010070	Germanium Diode	1S1007
					D302, 303	21090115	"	1N60
MIX UNIT								
					MONOLITHIC FILTER			
Symbol Number	Parts No.	Description			XF301	71200018	9M20A	
PB1631A	60416311	Printed Circuit Board						
	016311AZ	PCB with Components						
CRYSTAL FILTER								
					FET & TRANSISTOR			
Q202	23800401	FET		3SK40M	XF302	71000010	XF90A	
Q201	22305351	Transistor		2SC535A				
RESISTOR								
					R305, 306, 310, R320	40143101	Carbon Film	¼ VJ 100Ω
					R304	40143221	"	220Ω
D201, 202, 207, D208	21015550	Silicon Diode		1S1555	R309	40143561	"	560Ω
D203~206	21090134	Schottky barrier		1SS16	R307, 311, 313, R314	40143102	"	1KΩ
					R312	40143122	"	1.2KΩ
RESISTOR								
					R301, 321	40143222	"	2.2KΩ
R207	40143120	Carbon Film	¼ VJ	12Ω	R302	40143332	"	3.3KΩ
R202, 215	40143101	"	"	100Ω	R322, 324	40143103	"	10KΩ
R206, 208, 213	40143151	"	"	150Ω	R308	40143153	"	15KΩ
R201	40143331	"	"	330Ω	R323	40143333	"	33KΩ
R205	40143332	"	"	3.3KΩ	R316	40143104	"	100KΩ
R203, 209	40143472	"	"	4.7KΩ	R317	40143105	"	1MΩ
R204	40143562	"	"	5.6KΩ				
R210	40143103	"	"	10KΩ				
R212	40143333	"	"	33KΩ				
CAPACITOR								
					C311	30829510	Ceramic	50WV SL 51PF
					C309	30820102	"	0.001μF

For Service Manuals Contact
MAURITRON TECHNICAL SERVICES
8 Cherry Tree Rd, Chinnor
Oxon OX9 4QY
Tel: 01844-351694 Fax: 01844-352554
Email: enquiries@mauritron.co.uk

C301~303, C306~308, C310, 312, C315~318	30820103	Ceramic 50WV	0.01μF			CAPACITOR	
				C401, 407	31820101	Ceramic 50WV 100PF(CH)	
				C404, 405, C408~410, 414, C418, 421~423, C426, 428	30820103	" " 0.01μF	
C304	36526334	Tantalum 50WV	0.33μF				
C313	36226105	" "	1μF				
C305	34220106	Electrolytic 16WV	10μF				
				C402, 403, 406, C412, 429~431	30820473	" " 0.047μF	
				C411, 425	33824120	Dipped Mica 50WV 12PF	
		INDUCTOR		C419	33824330	" " " 33PF	
L301	53020001	Micro Inductor	1mH	C415	33824390	" " " 39PF	
				C420	33824101	" " " 100PF	
				C417	33824121	" " " 120PF	
		TRANSFORMER		C416	33824271	" " " 270PF	
T301, 303, 305	55003234		#220275	C427	36226335	Tantalum 16WV 3.3μF	
T304	55003235		#220276	C424	36226475	" " 4.7μF	
T302	54141710	R12-4171	#220141	C413	34826476	Electrolytic 50WV 47μF	
						TRIMMER CAPACITOR	
				TC401	39000007	ECVIZW 20x40	
IF UNIT							
Symbol Number	Parts No.	Description				INDUCTOR	
PB-1625B	60416252	Printed Circuit Board			L401	53010002	Micro Inductor 22μH
	016252AZ	PCB with Components			L404, 405	53010003	" " 250μH
				L402, 403	53020001	" " 1mH	
		FET & TRANSISTOR					
Q403, 40	28900195	FET	2SK19GR				
Q401, 402	23800401	"	3SK40M			TRANSFORMER	
Q407	22106281	Transistor	2SA628A	T401	54141700	R12-4170 #220140	
Q405, 406	22303724	"	2SC372Y	T402	54141710	R12-4171 #220141	
		DIODE					
D401~403	21015550	Silicon Diode	1S1555				
MOD/DEM UNIT							
		CRYSTAL			Symbol Number	Parts No.	Description
X401	71800107	HC-18/U	8999.3KHz	PB-1624B	60416242	Printed Circuit Board	
					016242AZ	PCB with Components	
		RESISTOR					FET & TRANSISTOR
R415	40143479	Carbon Film ¼ VJ	4.7Ω	Q501	22800194	FET 2SK19Y	
R434, 435	40143100	" " " "	10Ω	Q502, 503	22303724	Transistor 2SC372Y	
R432	40143820	" " " "	82Ω				
R407, 414, 416, R418, 431, 436	40143101	" " " "	100Ω			DIODE	
R406, 413, 420	40143151	" " " "	150Ω	D501~504, D509~512	21010070	Germanium Diode 1S1007	
R417	40143331	" " " "	330Ω	D505~508	21015550	Silicon Diode 1S1555	
R422	40143471	" " " "	470Ω				
R430	40143561	" " " "	560Ω				
R423	40143102	" " " "	1KΩ				
R425, 433	40143222	" " " "	2.2KΩ			CRYSTAL	
R429	40143272	" " " "	2.7KΩ	X501	71800094	HC-18/U 8998.5KHz	
R421, 426, 427, R428	40143103	" " " "	10KΩ	X502	71800095	HC-18/U 9001.5KHz	
R403, 410	40143223	" " " "	22KΩ				
R401, 402, 408, R409	40143563	" " " "	56KΩ			RESISTOR	
R405, 412, 419, R424	40143104	" " " "	100KΩ	R506, 510, 514	40143101	Carbon Film ¼ VJ 100Ω	
R404, 411	40143124	" " " "	120KΩ	R502, 515, 516	40143151	" " " " 150Ω	
				R501, 503, 513	40143331	" " " " 330Ω	
				R505	40143471	" " " " 470Ω	
				R508, 509, 518	41143471	" " ¼ TJ 470Ω	
				R507	40143102	" " ¼ VJ 1KΩ	
		POTENTIOMETER		R504, 511, 512	40143103	" " " " 10KΩ	
VR401	49917501	V8K 1-1	500Ω	R517	40143104	" " " " 100KΩ	

		POTENTIOMETER		R606, 617	40143153	Carbon Film ¼ VJ 15KΩ	
VR501	49912501	V10K 8-1-2	500Ω	R603	40143393	" " " "	39KΩ
VR502	49917501	V8K 1-1	500Ω	R610	40143563	" " " "	56KΩ
				R602	40143154	" " " "	150KΩ
		CAPACITOR				CAPACITOR	
C504, 505	31820101	Ceramic 50WV CH	100PF				
C501, 502, C506~510, C513, 516, 517, C520, 522	30820103	" "	0.01μF	C625	30820473	Ceramic 50WV	0.047μF
				C609	36825222	Mylar "	0.0022μF
				C607	36825472	" "	0.0047μF
C518, 519	36825104	Mylar "	0.1μF	C601, 613, 616, C621	36825473	" "	0.047μF
C521	33824240	Dipped Mica "	24PF	C624	36825104	" "	0.1μF
C522, 512	33824270	" " "	27PF	C610	34220105	Electrolytic 16WV	1μF
C503	33824390	" " "	39PF	C605	34220225	" "	2.2μF
C523	33824470	" " "	47PF	C608, 611, 612	34220106	" "	10μF
C514	33824151	" " "	150PF	C618	34220226	" "	22μF
C515	33824471	" " "	470PF	C622	34220476	" "	47μF
				C604, 606, 614, C619, 626	34220107	" "	100μF
		TRIMMER CAPACITOR		C617, 623	33824500	Dipped Mica 50WV	50PF
TC502~504	39000007	ECV1ZW 20x40		C603	33824271	" " "	270PF
TC501	39000008	" 50x40		C620	33824391	" " "	390PF
		INDUCTOR				HEAT SINK	
L501~505	53020001	Micro Inductor	1mH		80019512	001951A	
L506	53020030	" "	68mH				
		TRANSFORMER					
T501	54141710	R12-4171	#220141				
				REG CONT UNIT			
				Symbol Number	Parts No.	Description	
		RELAY		PB-1622B	60416222	Printed Circuit Board	
RL501	70000034	BR211 AD 009M	DC9V		016222AZ	PCB with Components	
		For Service Manuals Contact MAURITRON TECHNICAL SERVICES 8 Cherry Tree Rd, Chinnor Oxon OX9 4QY Tel: 01844-351694 Fax: 01844-352554				IC, FET & TRANSISTOR	
				Q703	26000023	IC	μPC14308
				Q704	22800194	FET	2SK19Y
				Q701, 702	22303724	Transistor	2SC372Y
				Q705	22307354	"	2SC735Y
		RF UNIT					
Symbol Number	Parts No.	Description					
PB1648A	60416481	Printed Circuit Board					
	016481AZ	PCB with Components				DIODE	
				D702~704	21015550	Silicon Diode	1S1555
		IC & TRANSISTOR		D701	21090115	Germanium	1N60
Q601	25000134	IC	TA7063P				
Q603	25000162	"	TA7205AP				
Q602	22310005	Transistor	2SC1000GR			RESISTOR	
				R713	40143101	Carbon Film ¼ VJ	100Ω
				R716	40143681	" " " "	680Ω
		DIODE		R706, 711	40143102	" " " "	1KΩ
D601	21015550	Silicon Diode	1S1555	R710	40143222	" " " "	2.2KΩ
				R705	40143392	" " " "	3.9KΩ
				R701, 702, 708	40143472	" " " "	4.7KΩ
		RESISTOR		R703	40143562	" " " "	5.6KΩ
R605, 612	40143331	Carbon Film ¼ VJ	330Ω	R717	40143103	" " " "	10KΩ
R607	40143391	" " " "	390Ω	R709	40143153	" " " "	15KΩ
R608	40143561	" " " "	560Ω	R704	40143223	" " " "	22KΩ
R618, 619	40143102	" " " "	1KΩ	R707	40143473	" " " "	47KΩ
R614	40143222	" " " "	2.2KΩ	R712	40143104	" " " "	100KΩ
R615	40143272	" " " "	2.7KΩ	R714	42143475	Carbon Composition	
R613	40143332	" " " "	3.3KΩ			¼ GK	4.7MΩ
R601	40143472	" " " "	4.7KΩ				
R611	40143562	" " " "	5.6KΩ				
R604, 609, 616	40143103	" " " "	10KΩ				

		POTENTIOMETER		C1001, 1003, C1007, 1013, C1014	30820103	Ceramic 50WV 0.01 μ F
VR901	49917103	V8K 1-1	10K Ω			
				C1005, 1009, C1010	30820473	" " 0.047 μ F
		CAPACITOR				
C901~908, C911~914, 917, C918	30820103	Ceramic 50WV	0.01 μ F	C1006	33824241	Dipped Mica " 240PF
C915	30820473	" "	0.047 μ F	C1012	36226684	Tantalum 16WV 0.68 μ F
C909, 910	31820101	" "	CH 100PF	C1011	34220226	Electrolytic " 22 μ F
C916	33824241	Dipped Mica "	240PF			
						INDUCTOR
				L1001	53020001	Micro Inductor 1mH
		INDUCTOR				
L902, 903	53010003	Micro Inductor	250 μ H			TRANSFORMER
L901, 904	53020001	" "	1mH	T1001	55003176	#220210
		TRANSFORMER				FERRITE BEADS
T901	55003231		#220269	FB1001, 1002	56000024	4A-R1 3x3-1H
		FERRITE BEADS				
FB901	56000024	4A-R1	3x3x1H			
		For Service Manuals Contact MAURITRON TECHNICAL SERVICES 8 Cherry Tree Rd, Chinnor Oxon OX9 4GY Tel: 01844-351694 Fax: 01844-352554 Email: enquiries@mauritron.co.uk				
				FIX UNIT		
				Symbol Number	Parts No.	Description
				PB-1629B	60416292	Printed Circuit Board
					016292AZ	PCB with Components
		PRE DRIVE UNIT				
		Symbol Number	Parts No.	Description		TRANSISTOR
		PB-1632A	60416321	Printed Circuit Board		Transistor 2SC372Y
			016321AZ	PCB with Components		
		IC, FET & TRANSISTOR				RESISTOR
Q1003	25000114	IC	MC14011BCP	R1105, 1106	40143101	Carbon Film $\frac{1}{4}$ VJ 100 Ω
Q1001	22800195	FET	2SK19GR	R1103	40143102	" " " " 1K Ω
Q1004	22303730	Transistor	2SC373	R1101	40143103	" " " " 10K Ω
Q1002	22390006	"	2N4427	R1104	40143223	" " " " 22K Ω
				R1102	40143333	" " " " 33K Ω
		DIODE				
D1001	21015550	Silicon Diode	1S1555			CAPACITOR
D1002	21090034	Zener "	WZ090	C1108	31820100	Ceramic 50WV CH10PF
				C1109	31820150	" " " " 15PF
				C1110~1112	30820103	" " " " 0.01 μ F
		RESISTOR		C1101~1105	33824150	Dipped Mica " 15PF
R1005, 1009	40143100	Carbon Film $\frac{1}{4}$ VJ	10 Ω	C1106	33824151	" " " " 150PF
R1010	40143151	" " " "	150 Ω	C1107	33824301	" " " " 300PF
R1011	41143221	" " $\frac{1}{4}$ TJ	220 Ω	C1113, 1115	33824471	" " " " 470PF
R1003	40143391	" " $\frac{1}{4}$ VJ	390 Ω	C1114	33824821	" " " " 820PF
R1007	40143102	" " " "	1K Ω			
R1008	40143182	" " " "	1.8K Ω			
R1004	40143222	" " " "	2.2K Ω			TRIMMER CAPACITOR
R1001	40143332	" " " "	3.3K Ω	TC1101~1105	39000009	ECV1ZW 50x40
R1012, 1014	40143103	" " " "	10K Ω			
R1015	40143123	" " " "	12K Ω			
R1013	40143333	" " " "	33K Ω			INDUCTOR
R1002	40143104	" " " "	100K Ω	L1101	53020001	Micro Inductor 1mH
R1006	42184101	Carbon Composition 18 GK	100 Ω	L1102, 1103	53020014	" " 1.8 μ H
						CRYSTAL SOCKET
		CAPACITOR			69010012	SD0105
C1004	31820101	Ceramic 50WV CH	100PF			
C1002, 1008	30820102	" "	0.001 μ F			

VFO UNIT (3310)					TERMINAL
Symbol Number	Parts No.	Description		90000000	1P Lighthouse Type
PB-1440A-3310	60414401	Printed Circuit Board		91100003	TP-B
	014401AZ	PCB with Components			
		FET & TRANSISTOR			
Q1202	22800195	FET 2SK19GR			
Q1201, 1203	22303724	Transistor 2SC372Y			
			10WPA UNIT (3310)		
			Symbol Number	Parts No.	Description
		DIODE	PB-1443-3310	60414430	Printed Circuit Board
D1202	21015550	Silicon Diode 1S1555		014430AZ	PCB with Components
D1201	21022360	Varactor " 1S2236			TRANSISTOR
			Q1301	22315890	Transistor 2SC1589
			Q1302, 1303	22390009	" MRF433
		RESISTOR			
R1210, 1211	40143101	Carbon Film 1/4W VJ 100Ω			
R1207	40143221	" " " " 220Ω			DIODE
R1212	40143471	" " " " 470Ω	D1302, 1303	21090019	Silicon Diode 10D10
R1205, 1208	40143222	" " " " 2.2KΩ	D1301	21009930	" " YZ033
R1202	40143332	" " " " 3.3KΩ			
R1201	40143103	" " " " 10KΩ			
R1203	40143183	" " " " 18KΩ			RESISTOR
R1204	40143333	" " " " 33KΩ	R1305	42124479	Carbon Composition
R1206, 1209	40143104	" " " " 100KΩ			1/2W GK 4.7Ω
			R1308, 1309	42124150	" " " " 15Ω
			R1303	42124220	" " " " 22Ω
			R1307	42124390	" " " " 39Ω
		CAPACITOR	R1310, 1311	42124101	" " " " 100Ω
C1223	31820070	Ceramic 50WV CH 7PF	R1302	42124331	" " " " 330Ω
C1203	31827070	" " UJ 7PF	R1301	42124391	" " " " 390Ω
C1201	31827080	" " " " 8PF	R1306	42124821	" " " " 820Ω
C1204	31820200	" " CH 20PF	R1304	43204680	Metalized Film 2W 68Ω
C1205	31820390	" " " " 39PF			
C1208, 1210, C1211, 1215, C1217, 1218	30820103	" " " " 0.01μF			CAPACITOR
C1206, 1222	30820473	" " " " 0.047μF	C1311	30830102	Ceramic 500WV 0.001μF
C1207	33824080	Dipped Mica " 8PF	C1312	30830472	" " " " 0.0047μF
C1209, 1214, C1216	33824330	" " " " 33PF	C1308	30820103	" 50WV 0.01μF
C1212	33824181	" " " " 180PF	C1301, 1302, C1304, 1306, C1309, 1310	30820473	" " " " 0.047μF
C1213	33824431	" " " " 430PF			
C1219, 1221	33824471	" " " " 470PF	C1315	30825105	" Chip " " 0.1μF
C1202, 1220	33824102	" " " " 1000PF	C1316	33834510	Dipped Mica 500WV 51PF
			C1313, 1314	36825224	Mylar 50WV 0.22μF
			C1307	34220105	Electrolytic 16WV 1μF
		VARIABLE CAPACITOR	C1303, 1305	34220336	" " " " 33μF
VC1201	39000027	C521A112B			
					INDUCTOR
		TRIMMER CAPACITOR	L1301, 1302	55003053	RFC #220032
TC1202	39000005	ECV-1ZW 50x32			
TC1201	39000070	TSN-100D15			
					TRANSFORMER
			T1301	55003051	T1301 #220024
		INDUCTOR	T1302	55003224	T1301 #220289
L1201	53003184	#220268			
L1205, 1206	53020014	Micro Inductor 1.8μH		80037583	Heat Sink 003758B
L1202, 1203	53010003	" " " " 250μH			
L1204	53020001	" " " " 1mH			
		RECEPTACLE	LPF UNIT		
J1201	67020001	CN3561	Symbol Number	Parts No.	Description
J1202	68030005	CN3965S	PB-1636	60416360	Printed Circuit Board
				016360AZ	PCB with Components

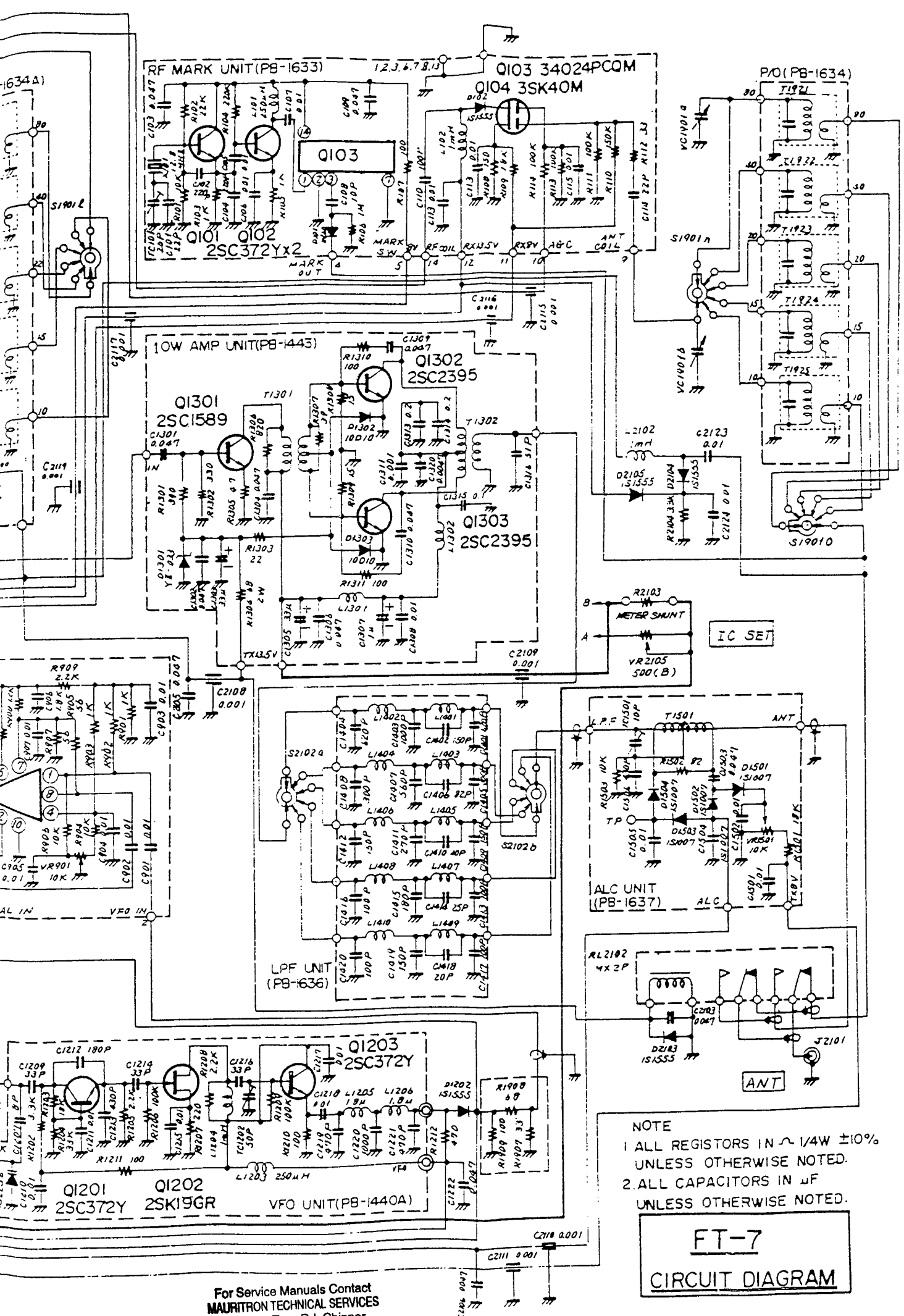

NOTE
 1. ALL RESISTORS IN $\pm 10\%$ UNLESS OTHERWISE NOTED.
 2. ALL CAPACITORS IN μF UNLESS OTHERWISE NOTED.

**FT-7
 CIRCUIT DIAGRAM**

For Service Manuals Contact
MAURITRON TECHNICAL SERVICES
 8 Cherry Tree Rd, Chinnor
 Oxon OX9 4QY
 Tel: 01844-351694 Fax: 01844-352554
 Email: enquiries@mauritron.co.uk