

FRG-9600 OPERATING MANUAL



YAESU MUSEN CO., LTD.

C.P.O. BOX 1500

TOKYO, JAPAN

CONTENTS

GENERAL DESCRIPTION	1
SPECIFICATIONS	2
FRONT PANEL CONTROLS	4
REAR PANEL JACKS	10
INSTALLATION	13
Initial Inspection	13
Physical Location of the Receiver	13
Power Connections	14
Mobile Installation	15
Antenna Installation and Connection	17
Mute Jack Connection	17
REC Jack Connection	18
Personal Computer Interconnection	18
OPERATION	20
FM Broadcast Reception (FM-W)	20
Memory Storage, Recall and Memory Scanning	22
Two-way Communications Monitoring (FM-N)	24
Airband Communications Monitoring (AM-W/AM-N)	26
Single-Sideband (SSB) Communications (LSB/USB)	27
Limited Band Operation	28
Priority Channel Monitoring	29
Clock/Timer Operation	31
REMOTE COMPUTER CONTROL (the CAT System)	34
MEMORY BACKUP INFORMATION	39

FRG-9600
ALL BAND, ALL MODE VHF/UHF
SCANNING RECEIVER



Providing features never been offered before, the FRG-9600 is an all mode scanner covering 60 through 905 MHz continuously, with 100 keypad-programmable memory channels.

In addition to FM wide (for FM and TV broadcasts), FM narrow (for two-way police, military, business and amateur communications) and AM wide and narrow (for aeronautical and amateur communications), the FRG-9600 also provides SSB (single sideband) reception up to 460 MHz, allowing reception of amateur and military SSB, as well as the new ACSB mode now used by the military and experimentally as the mode of the future for VHF. The SSB mode also provides for easy reception of CW (radiotelegraph), and a front panel tuning knob is provided to simplify tuning of SSB, CW and narrowband AM. Seven tuning/scanning rates between 100Hz and 100kHz assure quick and efficient tuning and scanning in all modes.

The scanning system allows either full or limited (keypad programmed) band scanning as well as memory channel scanning, with auto-resume. In addition to carrier sensing scan stop, audio scan stop sensing is also selectable, to avoid stopping on inactive "carrier-only" channels. Scanning steps are selectable, with the wide steps indicated on the front panel display. Signal strength is indicated by a two-color graphic S-meter on the display. A 24-

hour clock/timer is included, along with a recorder output, for automatic power on/off switching and recording of transmissions at any time. Additional jacks provide cpu band selection outputs, multiplexed (FM wide) output, AF and RF mute and other control signals for maximum expansion potential with future options or for those who wish to provide their own add-on hardware for special applications. A mobile mounting bracket is also supplied for automobile mounting.

The Yaesu CAT System provides a direct control link to the cpu in the FRG-9600, allowing operators with personal computers to add virtually unlimited customized control functions in software, such as multiple, organized memory banks, automatic tuning, and customized scanning systems, using most any personal computer and a Yaesu FIF CAT Interface Unit.

For AC operation the FRG-9600 requires one of the optional PA-4 series AC Adapters, available from all dealers where the receiver is sold. A TV Video IF Unit may also be installed as an option, allowing reception of TV pictures (NTSC format) with a video monitor connected to the video jack on the rear panel.

§ § § § § § S P E C I F I C A T I O N S § § § § § §

Frequency range:	60-905 MHz (up to 460 MHz for SSB)
Modes, 3dB Bandwidth:	FM Narrow (15 kHz BW) FM Wide (180 kHz BW) AM Narrow (2.4 kHz BW) AM Wide (6 kHz BW) SSB (2.4 kHz BW)
Conversion schemes:	Triple (FM-N, AM, SSB) Double (FM-W) Single (Optional TV Video Unit)
Intermediate Frequencies:	45.754, 10.7 MHz and 455 kHz

Image Rejection:	60 – 460 MHz	-50dB typical
	460 – 905 MHz	-40dB typical
Typical Sensitivity:	FM-N	0.5uV (for 12dB SINAD)
	FM-W	1.0uV (" " ")
	AM-N	1.0uV (for 10dB S+N/N)
	AM-W	1.5uV (" " ")
	SSB	1.0uV (for 15dB S+N/N)
Tuning steps:	FM-N*	5 / 10 / 12.5 / 25 kHz
	FM-W	100 kHz
	AM-N	100 Hz / 1 kHz
	AM-W*	5 / 10 / 12.5 / 25 kHz
	SSB	100 Hz / 1 kHz
	*Selected steps shown on display	
Memory channels:	100	
Audio output:	1W (into 8 ohms, with less than 10% THD)	
Power supply voltage:	DC 12 - 15V	
Power supply current:	Operating	550 mA (maximum)
	Power switch off	100 mA
	DC supply off	3 uA max. (backup)
Case size (WHD):	180 x 80 x 220 (mm)	
Weight:	2.2 kg (4.9 lb) without options	
Supplied accessories:	Whip Antenna (0.6m) DC Power Cord (1.8m) MMB-28 Mobile Mounting Bracket Wire Stand	
Options:	AC-DC Wall Adapter (PA-4B for 110-120V, or PA-4C for 220-240V) Video Unit (NTSC) SP-55 External Speaker	

FRONT PANEL CONTROLS

Before connecting power to the receiver, please read the "Installation" section of this manual, beginning on page 13.

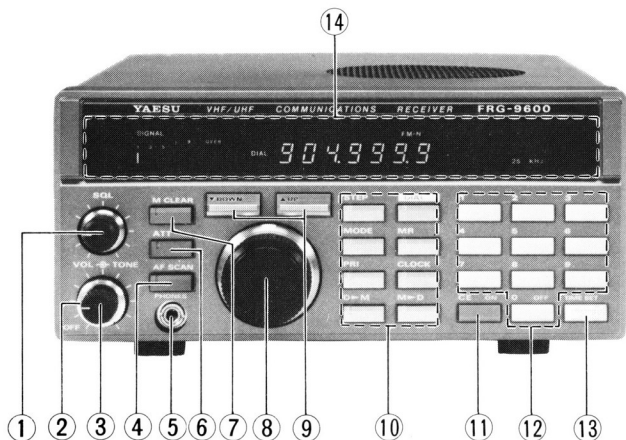

(1) SQL (Squelch)

This control adjusts the sensitivity of the all mode squelch system, which quiets the receiver audio unless a signal is received that is stronger than the threshold level set by this control. If you want to hear all signals (strong and weak), this control should be set fully counterclockwise. However, for normal FM-N and AM reception this control should normally be rotated clockwise just to the point where the received noise disappears (FM) or is reduced (AM, SSB). This control is disabled in the FM-W mode [see (19) on page 11].

(2) TONE (outer knob)

This control adjusts the treble and bass response of the audio amplifier in the receiver, to allow most comfortable listening. Normally it is set to about the center (12 o'clock) position, with clockwise rotation decreasing the bass response, and counterclockwise vice-versa.

(3) VOL (and **OFF**)

This (inner knob) is the main ON/OFF switch and volume control for the receiver. It should be adjusted for a comfortable volume on a signal or noise when the SQL control is set counterclockwise. Rotate the control fully counterclockwise into the click-stop to switch off the receiver when it is not being used. The clock/timer and memory backup functions will not be affected.

(4) AFSCAN

This two-position gray push button selects the scan-stop condition. In the undepressed (out) position the scanner will stop whenever any signal is detected (whether or not it is modulated by voice). When this switch is depressed, the scanner will stop only on those signals that have audio modulation, skipping over unmodulated carriers.

(5) PHONES

Standard monaural or stereo headphones with either a 2- or 3-contact plug may be connected to this jack. Either arrangement will reproduce the (monaural) audio in both ears. Inserting a plug into this jack disables the internal speaker, or external speaker if connected. Impedance of the headphones should be 32 ohms for best results.

(6) ATT (ATTenuator)

This two-position gray push button decreases the level of all signals from the antenna, to protect the receiver input from over-

loading by very strong signals. Normally this button is not depressed, providing maximum receiver sensitivity.

(7) M CLEAR (Memory Clear)

Pressing this gray button when receiving on a memory channel clears all data from that channel (a beep will sound) and transfers the frequency and mode data to the Dial, automatically switching reception to the Dial state. That memory will then be vacant (and thus ignored by the scanner) until data is rewritten to it from the Dial state. This button is disabled while receiving in the Dial state.

(8) Tuning Knob

This knob allows convenient step-tuning across the band in the Dial state, or through the memories. Tuning steps are determined by the MODE and STEP buttons.

(9) DOWN and UP keys

If pressed momentarily, these two large metallic keys move the displayed receiving frequency down or up by one tuning step when the receiver is in the Dial state, or to the next (stored) memory channel when in the Memory state. If pressed and held for more than a half-second, the scanner will be activated. Press either of these keys again to deactivate the scanner.

(10) Small Metallic Function Keys

A beep will sound when any function controlled by these keys is activated. If a beep does not sound, or if two beeps sound in quick succession, the function is not activated because that function is not accessible in the current operating state.

STEP selects the frequency steps for tuning and scanning in the Dial state. These are 100Hz or 1kHz for LSB, USB and AM

narrow, and 5, 10, 12.5 or 25 kHz for AM wide and FM narrow (step size for these latter two modes is shown at the right side of the display). This key is disabled in the FM wide mode, and at all times in the Memory state.

MODE selects the receiver detector type and IF bandwidth when receiving in the Dial state. Repeated pressing of this key cycles through the modes as follows;

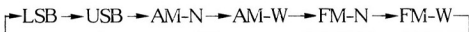

The selected mode is displayed just above the frequency. The MODE key is deactivated when receiving on a memory.

PRI (Priority) toggles the automatic priority channel checking function on and off. This function momentarily tests a preselected "priority" memory for activity every three seconds during normal reception on other frequencies. See the "Operation" section for details.

D - M (Dial-to-Memory) transfers the frequency and mode data from Dial to a memory. The memory channel (two digits) must be keyed in beforehand or the data will be stored in the last selected memory. Pressing this key does not change the selected state (Dial or Memory); it only transfers the data.

DIAL selects the Dial state (from the Memory state). The frequency and mode last used in the Dial state will be recalled (so the Dial actually serves as a 101st memory). Specific details are provided in the "Operation" section.

MR (Memory Recall) selects reception on a memory (the Memory state) after receiving in the Dial state. If a two-digit memory channel number is keyed in before pressing this key, memory operation will be on that memory channel; otherwise, operation will be on the memory that was last used (before the Dial state was last entered), unless that memory was cleared. See the "Operation" section.

CLOCK displays the clock/timer status (without affecting reception). The first press of this key activates the clock display and allows setting of the time (by the numeric keypad). Pressing the **CLOCK** key again activates the Timer On mode, which displays (and allows resetting of) the time at which the receiver will be switched on automatically. Pressing **CLOCK** again activates the Timer Off mode, which is similar to the Timer On mode. Pressing **CLOCK** once more activates the Timer Off/On select mode, indicated by display of a single decimal in the center of the display:

┌─TIME ─ON TIME ─OFF TIME ─"." (ON/OFF)─┐

To escape the clock/timer status and return to frequency display, press **DIAL** or **MR**. See the "Operation" section of this manual for more details.

M - D (Memory-to-Dial) transfers the frequency and mode data from memory to the Dial, overwriting previous data in the Dial. The source memory channel digits may be keyed in first, or the (last) selected memory will be transferred. Operation will always be shifted to the Dial when this key is pressed, and the original memory data will remain intact (in the memory channel). This button is also used in conjunction with the **DOWN/UP** keys for Limited Band Operation, described later.

(11) **CE [ON]** (Clear Entry & Timer On)

The Clear Entry function of this blue key allows cancellation of numerical digits that have been entered by mistake on the keypad. The Timer On function is used only in the timer **ON/OFF** select mode (when the display shows only a single decimal and "OFF" or "ON OFF"), to toggle the auto-ON timer on and off.

(12) **White Keypad Keys: 1 - 9 and 0 (OFF)**

The numeric keys allow entry of frequency, memory channel or clock/timer setting, according to the operating status of the

receiver selected by the metallic function buttons. In the timer ON/OFF select mode the "0" key toggles the auto-OFF timer.

(13) TIMER SET

This orange key is enabled only in the clock/timer modes, to set the clock and On or Off times after keying in the desired time digits on the keypad.

(14) Display

During regular reception the display shows the relative received signal strength on the 2-color bar-graph indicator at the left, and frequency in the center, with the reception mode indicated just above the frequency digits. When receiving in the Memory state, the 2-digit memory channel number is displayed at the right. PRI or DIAL is indicated between the bar-graph and frequency when these are activated. OFF or ON/OFF are shown just above the memory channel when these timer functions are activated. In the clock/timer modes only time (or ".") is displayed, and on/off status, when set.

PLUG CONNECTIONS



Stereo headphone mini-plug

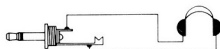

Monaural headphone mini-plug

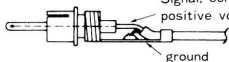

+8V, MUTE, VIDEO plug



EXT SPKR plug
Stereo Demultiplexer etc.

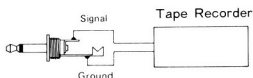

MPX, REC plug

REAR PANEL JACKS

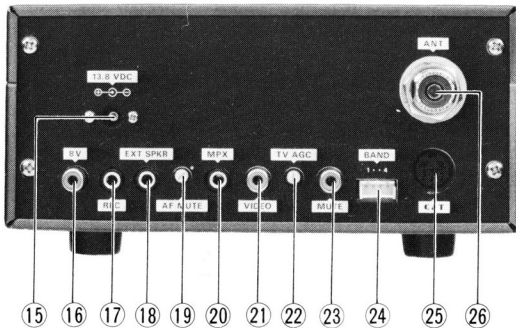

(15) 13.8 VDC

This coaxial jack accepts the DC supply voltage for the receiver (12 – 15 VDC). Current is 550 mA when the receiver is on, and 100 mA when off. The supply should be connected all the time to retain clock/timer settings. The optional PA-4B or -4C Wall Adapters can be used to supply the operating voltage from the AC line, but AC voltage must never be connected directly to this jack. See the "Installation" section for further details and important precautions.

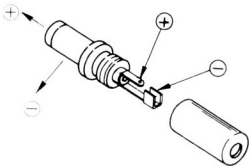

(16) 8 V

This RCA jack provide 8 VDC $\pm 10\%$ at up to 200mA for powering external devices. The center contact is positive.

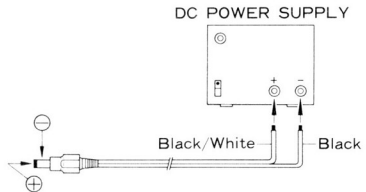

(17) REC

This jack provides constant level (approx. 70mV @50 kilohms) audio output, which is unaffected by the VOL and TONE controls: for tape recording or data decoding purposes where a constant audio level is required.

(18) EXT SPKR (External Speaker)

This two-contact mini phone jack is for connection of an external loudspeaker such as the Yaesu SP-55, with an impedance of 4 to 16 ohms. When a plug is inserted into this jack the internal speaker is disabled.

(19) AF MUTE (potentiometer)

This control sets the squelch threshold level at which signals will be heard in the FM-W mode (only). It should normally be set so that noise and signals that are too weak to be heard clearly (without distortion) are muted.

(20) MPX (Multiplex)

This 2-contact mini phone jack provides output from the FM-W detector (in the FM-W mode), for an external stereo demultiplexer (not available from Yaesu). Level is approximately 400 mVrms at 50 kilohms, with -6dB ripple between 20Hz and 60kHz.

(21) VIDEO

This RCA jack provides baseband video output (approx. 1Vp-p) when the optional Video Unit is installed in the receiver; for connection to a video monitor.

(22) TV AGC (potentiometer)

This control allows adjustment of the video Automatic Gain Control, which provides constant level video output with varying received signal levels when the optional Video Unit is installed.

(23) MUTE

This RCA jack allows disabling the receiver (in any mode), by shorting the center and outer contacts of the jack. This should be done whenever the FRG-9600 is used in conjunction with a transmitter. Do not apply any voltage to this jack.

(24) BAND

This 4-pin molex jack provides binary band data (on three pins, the other being signal ground) for possible future options. Maximum open circuit voltage that may be applied is 30V.

(25) CAT

This 6-pin DIN jack provides connections for a microcomputer interface unit (such as the Yaesu FIF-series). Pin-out is shown on page 36.

(26) ANT

This type M coaxial jack is for connection of the antenna. The supplied telescoping whip antenna may be used for casual listening, but a proper outdoor antenna should be used for optimum performance. See the "Installation" section next.

YAESU CAT SYSTEM INTERFACE UNITS

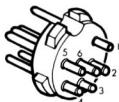

- PIN 1: GND
- 2: N.C
- 3: SI (Serial In)
- 4: N.C
- 5: S-Meter
- 6: BUSY

CAT PLUG



FIF-232C
(for RS-232C)

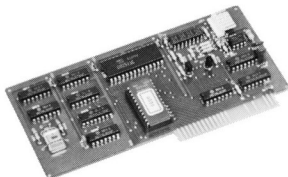

FIF-65A
(for Apple II)

§ § § § § § § **INSTALLATION** § § § § § § §

Proper performance of the FRG-9600 depends on correct installation. Please take time to study this section carefully before connecting the receiver to the power source. While the setup procedure for the FRG-9600 is simple, permanent damage to the receiver can occur if improper voltage is applied or if external connections are improperly made.

Initial Inspection

After carefully removing the FRG-9600 from the carton, inspect it for any signs of physical damage. Rotate the knobs and push the buttons, checking each for normal freedom of action. If damage is suspected write down your observations and notify the shipping company (if the set was shipped to you), or your dealer immediately. Save the carton and packing material for possible use later.

Physical Location of the Receiver

The FRG-9600 can be located just about any place, but there are a few important factors to keep in mind for certain installations. Of course it will be necessary to keep the top panel clear if the internal speaker is to be used, and necessary space for the rear panel connectors and access to the front panel controls should be considered - especially in mobile mounting. Do not locate the FRG-9600 in front of a heater vent or directly above a heat-generating device.

There are two other factors to consider in certain applications: the distance to the antenna feedpoint (when the receiver is used with an external antenna), and the proximity and grounding or shielding of computer equipment (when the FRG-9600 is used in conjunction with same). For optimum reception the receiver should be located as close to the antenna as possible, so that the feed-line length is kept to a minimum. However, unless a computer is

well shielded for RF noise (a rare case), the antenna may pick up objectionable noise from the computer if they are very close to one another.

Experimentation in several different locations, perhaps with different ground connections, may be necessary to determine the best overall placement of the receiver, antenna and computer.

Power Connections

The FRG-9600 is equipped for operation from 12 to 15 volts DC, which may be supplied from the optional PA-4B or PA-4C AC-DC adapter when operating the receiver from the AC mains. The PA-4B is for use with 110-120VAC only, while the PA-4C is for use with 220-240VAC only.

The FRG-9600 requires 550mA when the receiver is on, and 100mA for clock/timer operation when the receiver is off, so be sure that any battery or other DC source that will be used is capable of handling this current. The center pin of the coaxial 13.8V DC power jack on the receiver must be connected to the positive side of the DC source. Make certain that the plug that is used for this connector has the correct size hole for the center pin of the jack, and that the polarity is not reversed (or the receiver will be damaged). Be certain that the VOL control is set to OFF before connecting the power plug to the rear panel.

>>>>>>>>>> WARNING <<<<<<<<<<<<

NEVER APPLY AC POWER TO THE REAR PANEL POWER JACK OF THE RECEIVER. NEVER CONNECT DC VOLTAGE OF MORE THAN 15 VOLTS TO THE POWER JACK. MAKE CERTAIN THAT THE CENTER CONTACT OF THE POWER JACK IS CONNECTED TO THE POSITIVE SIDE OF THE SUPPLY. FAILURE TO OBSERVE THESE PRECAUTIONS WILL DAMAGE THE EQUIPMENT AND VOID THE WARRANTY.

The SP-55 External Speaker is an optional accessory for the FRG-9600, allowing the source of audio from the receiver to be repositioned for optimum hearing. Especially practical for the noisy mobile environment, the SP-55 includes its own swivel-type mounting bracket, and is available from your Yaesu dealer.

Mobile Installation

The FRG-9600 must only be installed in cars having a negative ground electrical system. The receiver should be located where the display and controls are easily accessible, and should be securely affixed using the supplied MMB-28 mobile mounting bracket. The receiver may be installed in any position without adversely affecting its performance, but it should not be mounted near a heater vent or where it could interfere with safe operation of the vehicle. Refer to the diagrams below and procedure on the next page for installation of the MMB-28.

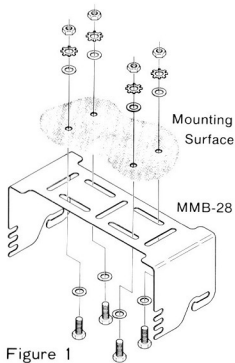

Figure 1

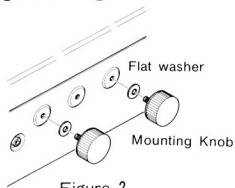

Figure 2

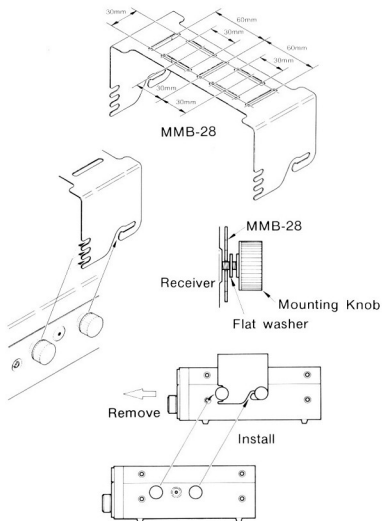

Figure 3

Mobile Mounting Procedure

- (1) Use the mounting bracket as a template for positioning the mounting holes, after determining the proper location with sufficient clearance for the receiver. Use a 3/16" bit for drilling the holes. Secure the bracket with the screws, washers and nuts supplied, as shown in Figure 1.
- (2) Screw the mounting knobs loosely to the receiver using the supplied flat washers as shown in Figure 2.
- (3) Referring to Figure 3, align the mounting knobs with the notches in the bracket, and slide the receiver backward and upward into the bracket. Then tighten the knobs to affix the receiver securely.

To remove the receiver from the bracket, first loosen the four knobs, and then pull the receiver straight forward, with slight upward pressure at the rear, if necessary.

Before connecting the power cable the maximum battery charging voltage should be checked to ensure that it remains below 15V when the engine is run fast. If more than 15V, the voltage regulator of the car should be adjusted before connecting the receiver.

Power connections may be made to the cigarette lighter or other convenient circuit, but if the supply is switched off when the motor stops, the clock will be reset to 00:00. Therefore, if clock operation is desired, an unswitched circuit should be used (or direct connection to the battery). In this case, remember that 100 mA will be drawn all the time, so the car battery charge will be depleted if the car lies unused for long. Use good quality insulated stranded copper wire, and make certain that POSITIVE (+) is connected to the center of the coaxial power plug.

Antenna Installation and Connection

The FRG-9600 is designed to operate only with an antenna connected to the rear panel connector. While the supplied telescoping whip antenna will give fair results on strong local signals on some frequencies if the radio is well located, optimum performance requires a good outdoor antenna located as high and in the clear as possible, with good quality coaxial feedline to the receiver.

Only 50-ohm coaxial cable should be used for the connection, and it should be as short as possible while still allowing the antenna to be mounted high above surrounding objects. For general AM and FM scanning and monitoring a vertical ground plane antenna is usually preferred, since it does not need to be rotated to cover all directions. However, in some locations a high gain unidirectional (vertical) yagi antenna is best, if most activity is in one direction from the receiving station, or if a rotator is available and the extra gain required. The best antenna performance will usually be obtained at some sacrifice of frequency coverage (bandwidth), so if optimum performance is to be achieved at all frequencies, several different antennas should be used. SSB, CW and TV modes generally use horizontal polarization, while FM uses vertical polarization; and this should be taken into account when choosing and installing the antennas. Contact your local dealer for advice on the best antenna for your needs.

MUTE Jack Connection

The MUTE terminal on the rear panel allows the receiver to be silenced during transmission when the FRG-9600 is used for two-way communication in conjunction with a transmitter or transceiver. Separate antennas, well isolated from one another, must be used to prevent damage to the receiver. Shorting the MUTE terminal contacts silences the receiver.

REC Jack Connection

Receiver audio is available at high impedance (50-kilohms) from the **REC** jack on the rear panel for direct connection to the high-impedance (HI-Z) audio input to a tape recorder. Shielded cable should be used for interconnections, to minimize noise pickup that might otherwise interfere with reception. Note that the VOL and TONE controls do not affect the audio at the **REC** jack.

Personal Computer Interconnection

The CAT System allows external control of the mode and frequency functions of the FRG-9600 via a variety of brands of personal computer (not available from Yaesu). "CAT" stands for "Computer-Aided Transceiver", since this system was originally developed for amateur radio transceivers.

Interconnection between the computer and receiver requires a digital interface unit, to convert parallel 8-bit ASCII data from the computer into 4800 bits/sec serial data at the correct voltage level required by the FRG-9600. Yaesu offers the **FIF-series CAT Interface Units** for this purpose. Some of these Units are for installation in particular brands of computers, but the FIF-232C Unit is designed for use with any computer that is equipped with an EIA standard RS-232C serial output port capable of 4800 bits/sec operation. Except for the FIF-232C, all of the Yaesu CAT Interface Units also include an analog-to-digital converter to allow the computer to measure the relative strength of received signals, for interactive operation between the computer and receiver, when so programmed.

The FIF interface units include a DIN plug for connection to the CAT jack on the rear of the FRG-9600, and some means of easy connection to (or installation within) the computer. The FIF-232C also requires connection to the AC line.

Additional details are provided at the end of the "Operation" section of this manual, and in the manual supplied with each FIF Interface Unit.

Note: While the FRG-9600 was designed to be well shielded against RF interference from computer noise, personal computers are generally not designed to limit the amount of RF noise that they produce, except within very broad limitations: some computers may produce enough noise to interfere with reception, particularly on lower frequencies. Some computer manufacturers and suppliers offer modifications and outboard noise filters to suppress RF noise, but Yaesu cannot accept responsibility for interference that may be caused by your computer. However, if such interference is encountered, it can often be minimized or eliminated by the following steps (first tune in the noise on the receiver, and switch the computer off and on to make sure that it is from your computer):

- (1) Locate the antenna as far as practicable from the receiver and computer, and use only the best coaxial cable feedline available, with proper connection to the coaxial jack on the receiver, and impedance matching at the antenna. This usually calls for a self-resonant (and generally narrow-band) antenna.
- (2) Pay special attention to the chassis grounding of the receiver and computer. In some cases it may be necessary to not connect the earth or receiver chassis ground to the computer chassis. A specially filtered signal ground line for the CAT System is provided in the CAT Interface cable. However, there is no fixed rule for grounding to minimize noise, so some experimentation may be necessary.
- (3) Use only good quality shielded cable for all external connections to the receiver, and to the computer. Noise can easily be picked up by a device such as an external speaker cable or tape recorder, and passed to the receiver. Disconnecting one accessory at a time from the receiver may help to isolate a culprit.

Basic operation of the FRG-9600 is quite simple. However, some of the advanced digital functions can be confusing at first if the operator is not familiar with the operation intended by the designers. Please read this section through carefully while trying out each function on the receiver, after making sure that the power and antenna connections have been made correctly, as described in the preceding section.

Rotate the VOL control out of the click-stop to turn on the radio. If it has not been used previously, the display will show "60.000.0" (MHz), in the "FM-N" mode, "5 kHz" steps at the left and "DIAL" to the right of the frequency. Otherwise, the frequency, mode and status last used (before the radio was last switched off) will be displayed. If you wish to clear all data (frequency, mode and memories) at any time, see the "Memory Backup" reset procedure on pages 39 and 40.

FM Broadcast Reception - the FM-W mode

The wide FM mode is described first, since it is generally the most universal in terms of frequency band and channel steps, and the simplest to receive. Make sure that the gray ATT and AF SCAN switches (to the left of the main knob) are set to their undepressed (out) positions. Press the MODE button (just to the right of the main knob) once, and verify that "FM-W" is now displayed above the frequency. If not, continue pressing the MODE button while watching for the correct mode display.

Use the white numerical keys to enter the frequency of a local FM broadcasting station (usually this will be between 88 and 108 MHz, but remember that most television stations also transmit their audio on FM-W). Note that if the frequency is below 100 MHz it will be necessary to key in "0" first. For example, if the station is at 90.5 MHz, press **0, 9, 0, 5**. Each time a digit is entered the next digit to the right will blink, indicating that

it is to be entered next (if needed - you need only enter the digits you wish to change). If you accidentally press the wrong digit key, just press the blue CE key to clear your entry and start over.

Once the desired frequency is shown on the display (with leading zero if below 100 MHz), press the DIAL button just below the display. The flashing digit will stop flashing, the leading zero (if present) will disappear, and the FRG-9600 will now be receiving on the entered frequency. Adjust the VOL control for comfortable volume, and the TONE control as desired.

Either the main tuning knob or the DOWN/UP buttons (above the knob) can be used to tune to a different station, if desired. Tuning steps will always be 100 kHz in the FM-W mode. Alternatively, the scanning function can be used if the AF MUTE control on the rear panel is set properly:

- (1) Using a small screwdriver, first set the control fully counterclockwise.
- (2) Tune to a clear channel (where only noise is heard), and gradually turn the control clockwise just to the point where the noise is silenced.

To activate the scanner press the DOWN or UP button and hold it for $\frac{1}{2}$ -second. The scanner will skip over vacant channels, and stop close to the next lower or higher station (a beep will sound). When the scanner has paused, the digits will each blink once from left to right. If you again press the DOWN or UP button the scanner will be disengaged, and you can then use the DOWN/UP buttons or main knob to tune in the station clearly.

If the DOWN or UP button is not pressed to disengage the scanner, it will resume scanning automatically after the rightmost digit has blinked. Note that, in this condition, the scanner will continue indefinitely in the same direction to the very edge of the receiving range (60 or 905 MHz), and then jump to the other

edge and keep scanning. Use Limited Band Operation, mentioned later, to keep the scanner within a certain range.

Memory Storage, Recall and Memory Scanning

The FRG-9600 has two "states" of operation, either Dial or Memory, selected by the DIAL and MR (Memory Recall) keys, respectively. The Dial state, used in the procedures above and indicated by "DIAL" shown just to the left of the frequency on the display, allows selection of frequency, mode and tuning steps, with unrestricted knob tuning, scanning or keypad entries anywhere within the range of the receiver. The Memory state, on the other hand, permits instant recall of any frequency and mode previously stored from the Dial state. Operation in the Memory state is indicated by the presence of "CH" and the memory channel number to the right of the frequency display. In the Memory state, scanning and channel stepping (with the DOWN/UP buttons) is in blocks of ten memory channels.

The 100 memory channels are numbered from 00 to 99. Note that two digits are always used to describe a channel (ie., 00, 01, 02, ... 09, 10, 11, etc.), since two digits must be used when entering a memory channel number on the keypad. For scanning purposes, each group of channels with the same ten's digit is one block, so channels 00 – 09 compose one block, 10 – 19 compose another, etc. When keying in memory channels 00 through 09, remember to enter the leading zero.

When a station has been tuned in as desired in the Dial state, just press the two memory channel number digits, and then D-M to store the Dial frequency and mode into that memory channel (operation remains in the Dial state).

Memory Storage Example:

In the FM-W mode, assume your favorite FM broadcasting stations are at 90.1, 95.6, 101.5, 103 and 104.5 MHz, and that you wish to store them in memory channels 90 through 94. First, in the Dial

state, tune in the station at 90.1 MHz using any of the tuning methods described above. Then press the "9" and "0" (white) keys, followed immediately with the D-M key (lower right side of the main knob). Next retune the dial to 95.6 MHz, and press "9", "1" and D-M. Then retune the dial to the next frequency, and press the keys to store channel 92, and so forth for channels 93 and 94.

When finished the receiver will still be in the Dial state. Note that the memory channels (90 - 94) chosen are all in the "90's". The 80's, 40's, or even 00's (00 - 09) could just as well have been used, but the fact that they are all in the same block will allow convenient channel stepping and scanning of these memories at a later time.

To recall the channels just stored, just press the MR key to enter the Memory state. Notice that "CH 94" appears. Even if the dial had been retuned to another frequency and mode, 104.5 MHz, FM-W would be recalled. To recall a memory other than the last one stored, just enter the memory channel digits on the keypad before pressing MR (of course the memory channel keyed in must have been stored at some time past).

Now rotate the tuning knob, or press the DOWN/UP keys to recall the other channels. If any other memories have been stored previously, they will be recalled when the tuning knob is used in the Memory state. When the DOWN/UP keys are used in the Memory state, only the selected block of memories will be recalled. When you want to remove memories stored in a particular block previously, press M CLEAR. Operation will shift to the Dial and the memory will be cleared, so it will be necessary to either restore data to that memory (from the Dial, press the memory digits and D-M), or recall another (occupied) memory by pressing the memory digits and MR.

Press and hold the DOWN or UP key for $\frac{1}{2}$ -second to scan the memory block. In this case, when more than one block of memories is stored, scanning will cover only the block containing the memory that is selected when the scanner is started. Later, when you

have stored memories in different blocks, the tuning knob will allow selection of any of the occupied memories (irrespective of blocks).

There are two possible ways to return to the Dial state from the Memory state; one shifting the receiving mode and frequency back to those last used in the Dial (just before MR was pressed), and the other overwriting the old Dial data with that of the selected memory. The first method is useful when you want to resume whatever you were doing before going to the memory(-ies): just press the DIAL button. Use the second method when you want to continue in the same band or mode as the memory, but need to tune around the memory frequency (or change the memory slightly): press the M-D (Memory-to-Dial) button.

Two-Way Communications Monitoring - the FM-N mode

To change modes from FM-W to FM-N (narrow), press the MODE button five times when in the Dial state. It is not possible to change modes in the Memory state.

Make sure that the gray ATT and AF SCAN switches are in their undepressed positions. Rotate the SQL control fully counter-clockwise, and then advance the VOL control for comfortable volume on the noise (or signal). Now turn the SQL control clockwise just to the point where the noise is silenced (turning it further will reduce sensitivity to weak signals). The setting of the SQL control in this way eliminates uncomfortable noise that would otherwise be heard when no signal is present on the receiving frequency, while still allowing signals to be received.

Narrow FM is now the most commonly used mode for two-way business, military and amateur communications on VHF and UHF in most countries of the world. However, channel spacing (tuning steps), especially on frequencies below 200 MHz, are often different from one area to another. 12.5 and 25 kHz steps are common in Europe, with 5 or 10 kHz steps more common elsewhere. Above 200 MHz wider

steps (25 kHz or greater) are used, so the 25 kHz setting should suffice. For now, unless you know the channel steps that are used in a particular band that you wish to monitor, use the smallest (5 kHz) steps; press the STEP button (just below the displayed frequency) while watching the right side of the display for the selected step size indication. Your Yaesu dealer may be able to tell you which steps are used on some bands, but in some cases this information may be unavailable, in which case you can find out by experimentation using the 5 kHz steps, as mentioned later.

Now tune to a frequency range known to have 2-way FM communications: 145 – 146 or 148 MHz, 222 – 225 MHz, or 430 – 440 or 440 – 450 MHz for amateur; or 68 – 88, 134 – 174, or 400 – 512 MHz for police, commercial business and marine. Mobile telephone also uses narrow FM, usually above 800 MHz. The nature and degree of activity on these bands, as well as their limits, vary widely from one country to another, so some exploring may be necessary. Note that two-way communications are distinct from broadcasting in that stations do not normally transmit constantly, so a frequency that is vacant at one minute may be crowded with activity the next. The section on Limited Band Operation will describe the most convenient way to watch the band. The above frequencies are meant only as general guidelines to get started.

Use the tuning knob or DOWN/UP keys to scan around the band until you find a signal. In some countries, constant-carrier repeaters are used. These transmit an unmodulated signal constantly, which may open the squelch (a slight hissing may be heard) even when no voice is present. Often, just listening to the frequency long enough will reveal who the users are. Also, signals in other modes may produce carriers or distorted sounds in FM-N. If this is suspected, try pressing the MODE button to check the other modes. If 12.5 kHz steps are used in your area, tuning in 5 kHz steps will result in some stations being impossible to tune in clearly. In this case just press the STEP button to select the right steps.

One other potential source of strange signals is intermodulation,

which is the interaction of very strong signals in the receiver. This can cause signals to appear in the receiver that are really not on the tuned frequency at all. If you find such strong signals (which produce a full or nearly full-scale indication on the signal meter), press the ATT button. In the depressed position, this button attenuates signals enough so that weaker signals may often be heard without interference from strong ones.

Scanning is similar to the FM-W mode described previously, except that the AF SCAN button may be depressed to prevent the scanner from stopping on stations that have only a carrier (with no audio modulation). The Memory functions are identical to those described in the previous section.

Airband Communications Monitoring - AM-W and AM-N

Practically the only AM (Amplitude Modulation) communications on VHF are in the aeronautical mobile band, from 118 to 136 MHz, using 100 kHz channel spacing (50 kHz in North America). Set the FRG-9600 to the AM-W mode, 25 kHz (the widest available) steps.

Communications are primarily between airport control towers and aircraft, with the AM wide mode being the best for general monitoring. Each airport generally has certain frequencies assigned to it, so the memories can be put to good use - storing the local airport frequencies together in one block of memories. Note that transmissions are not made constantly, so the band should be scanned to find the active frequencies in your area. See the Limited Band Scanning section below.

The SQL control for AM operation is set up in the same way as for FM-N, except that in AM the receiver is not completely quieted when the squelch is closed, but only reduced in volume. This allows any weak signals that the scanner may skip to still be heard, while reducing noise to a comfortable level.

The AM-N mode may provide better reception of weak stations, or

those having interference from nearby frequencies. However, fidelity will be reduced, so the AM-W mode should be used whenever possible. Tuning steps for AM-N are much finer than AM-W, so it is generally most convenient to tune in stations first in AM-W before switching to AM-N. The SQL control should be reset as required whenever changing modes.

Single-Sideband (SSB) Communications - LSB & USB modes

SSB has been used for amateur and military communicators for many years because of its greater efficiency, providing longer range with lower power than FM-N, and is now being experimented with for business communications at VHF and UHF, in the form of ACSB (Amplitude Companded Sideband). Typical (amateur) frequencies to monitor for SSB activity are 144 – 145 MHz and 430 – 440 MHz. Military SSB frequencies are harder to pinpoint, but may be found by scanning, particularly around 136 – 144 MHz in some areas. ACSB has not, as of this writing, been assigned any specific frequencies, but experiments are being carried out in the VHF business bands mentioned earlier for FM-N. ACSB signals are distinguishable by a weak, high-pitch "pilot" tone.

SSB signals require very careful fine tuning, provided by the fine (0.1 kHz) steps and the tuning knob. When the stepping buttons or scanner is used to find SSB signals, some fine tuning with the knob will generally be necessary to tune the signal clearly (so the voice sounds normal).

The majority of SSB signals at VHF and UHF are sent in the USB (Upper sideband) mode, and this should be the one normally selected for monitoring. If you find a signal that sounds like SSB but cannot be tuned clearly, switch to LSB and retune slightly.

The SQL control may be set as for FM-N, and signals will still be audible at reduced level when the squelch is closed. However, when tuning around for weak SSB signals it is best to keep the squelch open (SQL fully counterclockwise), since there is no carrier in SSB to keep the squelch open during pauses in speech.

Radio telegraphy (CW) stations may also be monitored with the FRG-9600, using either the USB or LSB modes. Amateur CW signals may be found with and just below the frequencies indicated previously for amateur SSB.

Limited Band Operation

Practical use of the scanner in any mode generally requires that the limits of the scanning range be set to correspond with the particular frequency band of interest. This is easily done in the FRG-9600, for any desired band, using two adjacent memory channels and the Dial. Not only are the scanning limits set, but also the tuning limits of the main dial: the receiver is actually programmed to behave like a limited band receiver.

The following example uses the procedure for the FM broadcast band between 88 and 108 MHz, but the same procedure may be used in any other mode or frequency range.

First select the desired mode (FM-W here), and tune the Dial to the high band edge (108 MHz) using the keypad (press **1, 0, 8, 0, 0** and DIAL), DOWN/UP buttons or main knob. Then store this in any memory channel (CH 01 for this example), pressing **0, 1** and D-M.

Next tune the Dial to the low band edge (88 MHz here), and store this in the next lower memory channel (CH 00), pressing **0, 0** and lastly, D-M.

Now to start limited band scanning, press M-D followed by the DOWN or UP button, holding this button in for $\frac{1}{2}$ -second. If the DOWN button is used to start, the scanner will begin at the high band edge (108 MHz) and scan to the low band edge (88 MHz) before jumping back to the high edge. If the UP button is used to start, scanning will begin at 88 MHz and work up to 108 MHz before jumping back to 88 MHz.

Note that the highest frequency is stored in the higher numbered

memory first, and that the receiver is operating on the lower numbered memory at the instant that the M-D button is pressed. If the highest frequency is stored in the lower numbered channel the limited scanning feature will still work and the DOWN/UP buttons correspond with the direction of frequency change, but it may be more difficult for you to remember. However, scanning will always be between the memory number selected when the M-D key is pressed and the next higher-numbered memory, so if the scanner does not loop within the desired range, you may have started it with the wrong memory. If nothing is stored in the next higher memory, the scanner will not be limited.

To deactivate limited scanning press the DOWN or UP button momentarily. Operation will be in the Dial state, but all tuning with the main knob or scanning with the DOWN/UP buttons will be limited to the preset band.

To escape from limited band operation, use the keypad to enter either another (occupied) memory channel, followed by the MR button; or key in another frequency and press DIAL.

Once the desired band limits are stored properly in the memories, limited band operation between those memories may be restarted at any time thereafter, without the necessity of leaving the Dial state, just by pressing M-D and DOWN or UP.

Priority Channel Monitoring

This feature allows periodic checking of one frequency for activity, while tuning around or listening on another frequency or mode. When a signal appears on the priority channel reception will automatically shift to that frequency. Priority monitoring is especially useful when waiting for emergency police or fire calls while listening to other stations.

Priority monitoring can be activated in either the Dial or Memory state, but will remain active only while receiving in that state.

Before activating the priority function, tune the Dial or select the memory channel for the desired priority frequency (and mode), and set the SQL so that the noise is just silenced. Press the PRI button, and "PRI" will appear to the left of the frequency display (with "DIAL" if in the Dial mode), indicating the priority function is now active.

Frequency and mode may now be changed as normal, as long as the state (Dial or Memory) is not changed. If receiving on the Dial, all buttons and controls can be used except the MR button (which will cancel priority operation and shift reception to memory). If in the Memory state, tuning knob and DOWN/UP buttons, and the D-M button may be used normally; the other buttons will be inactive or will cancel priority checking. The receiver will jump to the priority frequency (and mode) every few seconds, to check for activity. When a signal appears on the priority channel strong enough to open the squelch, the receiver will jump to the priority channel and stay there.

Limited band operation may be combined with the priority function, by first setting up limited band operation as described above, and setting the priority channel on the Dial (it can be recalled from a memory with M-D, if desired). Once the priority channel is set in the Dial, press MR and use the main knob to select the (prestored) memory on which to start limited band operation. Then press Dial and PRI to start priority checking, followed by M-D and DOWN or UP to start limited band operation.

The priority function is inactive while frequency scanning is activated, but will resume when scanning is stopped manually.

Priority monitoring may be cancelled by pressing the PRI button again, but this will set the receiver to the priority channel. If this is not desired, use the DIAL and MR buttons to momentarily change state, cancelling priority checking but saving the current receiving frequency.

Clock/Timer Operation

The clock/timer functions are displayed by pressing the CLOCK button, which cycles through the different functions as described in the "Front Panel Controls" section. Reception will not be affected, although the tuning controls will be disabled. Press the DIAL or MR buttons at any time to cancel the clock/timer display and return to the regular frequency display.

- (1) Press the CLOCK button once to display the clock time. This is in 24-hour format, so add 12 to hours after noon. To reset the clock, key in two hour's digits (with leading zero, if before 10 am) and two minutes digits (again, including zeros, if needed). Then press the orange TIME SET button at the exact minute.

The automatic power on/off timer in the FRG-9600 requires that the power switch be on (VOL control clockwise out of the click-stop) at all times when the timer is activated. Therefore, the OFF timer must be set to allow the timer to switch the receiver off, and only then can the ON timer be used (to switch the receiver back on automatically within the next 24 hours). If the power is manually switched off by the VOL control, the OFF timer will be deactivated (at least for the next 24 hours), and thus so also the ON timer. See the example below after studying the next steps.

- (2) Press the CLOCK button again to display the timer ON time, ("ON" will blink on the display). This may be set in the same manner as the regular clock (1). However, the ON timer will have no function unless the OFF timer (3) is also set.
- (3) Press the CLOCK button again to display the timer OFF time ("OFF" will appear blinking). This is also set in the same manner as above, and must be set if the automatic timer is to be used.
- (4) Press the CLOCK button again to display the timer status (either OFF, OFF/ON or inactive). If the timer is not

activated, only a decimal will be displayed. After the ON and OFF timers have been set in steps (2) and (3), they may be activated while the timer status is displayed;

OFF timer only - press (white) **0 OFF** key. "OFF" will appear (non-blinking) on the display whenever the receiver is on, and the receiver will turn off at time set in (3).

OFF/ON timer(s) - press the **0 OFF** key, and then the **CE ON** key. "ON OFF" will appear (non-blinking) whenever the receiver is on, and the receiver will turn off at the time set in (3), and back on at the time set in (2).

Timer Example:

Assume your local time is now 7 pm, and you are listening to the 10 minute VHF marine weather forecast on 162 MHz (in a memory channel, and shown on the display), which you would like to hear every evening at this time.

Press **CLOCK**, and check that the time display shows 19.00 (indicating 7 pm). If not, press "1", "9", "0", "0" and **TIME SET**.

Press **CLOCK** again, and check that "ON" is blinking at the upper right side of the display. Press the same five keys as in the previous step (to set the ON timer also to 7 pm).

Press **CLOCK** again, and check that "OFF" is now blinking. Press "1", "9", "1", "0" and **TIME SET**, to set the OFF timer to 7:10 pm.

Press **CLOCK** once more to enter the timer status mode, and press "0 OFF" to activate the OFF timer, and "CE ON" to activate the ON timer (OFF and ON should now appear).

Press **MR** to return to the receiver frequency display (or press

CLOCK again to return to the local time display). When the forecast finishes at 7:10 pm, the FRG-9600 will shut off. If you do not turn the VOL control off, the receiver will automatically switch back on at 7 pm the next evening (and every evening after).

If you turn the receiver off manually at any time, the timer will be deactivated (though all setting will be retained in memory as long as the DC supply is not interrupted). However, you can turn the receiver on manually after turning it off, and the timer will resume its activity at the OFF time (7:10 pm in this example).

Perhaps it should be called an "OFF/ON" timer, but once accustomed to its behavior you should have no trouble making use of the timer for preset listening times.

Note: if the DC supply is interrupted for more than about 10 seconds, all clock/timer setting will be reset to zero/off.

Remote Computer Control - the CAT System

The CAT (Computer-Aided Transceiver) System was originally developed for external control of Amateur Transceivers by external personal computers. The simplified but powerful version of this system in the FRG-9600 offers vast potential for expanding the present functions of the receiver, and adding new functions as may be desired for specialized reception techniques that are not possible with the receiver alone.

Physically, the CAT System is a serial data input port to the microprocessor in the FRG-9600, which accepts commands from an external computer via pin 3 of the CAT jack on the rear panel (pin 1 is ground). This control data must be sent in groups of five bytes, "TTL" level (0V="MARK" and +5V="SPACE"), with eight data bits, two stop bits and no parity, at 4800 bits/sec. Within the groups of five bytes, each byte must be sent within 200ms of the last. Since most computers are not equipped with an output port that provides this format, Yaesu offers the FIF-series CAT Interface Units (see page 12), the appropriate one of which should be installed between the computer and the receiver.

The CAT jack on the FRG-9600 also provides a sample of the AGC (S-meter) voltage at pin 5, and of the SCAN STOP (SCANNING=0V) status at pin 6. The AGC voltage can be converted into a digital pulse and used to inform the computer of the received signal level, either via the analog-to-digital converter in certain of the FIF-Units, or by an external A-to-D converter, either outboard, or in the computer. The SCAN STOP status can be passed to the computer via a TTL-level digital input port. While neither of these connections is necessary for external control, they do provide a means by which the operating condition of the receiver can be fed back to the computer, allowing interactive ("intelligent") control by the external computer.

External Control Programming

There are just two types of commands used to control the FRG-9600: Frequency Set and Mode Set. While this makes programming very simple, the tremendous flexibility that these offer when wisely applied in a creative program should be borne in mind. The CAT Command Chart shows the format of these commands. Note that the bytes are actually sent from left to right, chronologically on the serial data line, so that the Instruction byte is always sent first. For clarity, all bytes (8-bit values) are depicted in their hexadecimal (base 16) forms, with this indicated by an "H" appended to the two digits.

Frequency Set Command

This command has an Instruction byte (1) of the value 0AH, and has just one function: to change the receiving frequency to that encoded in bytes 2 - 5 of the command. The encoded byte values appear on the data line as they will appear on the frequency display, with the largest frequency increments (hundred's and ten's of MHz digits) in byte 2 sent first, and the smallest frequency increments (least significant digits, 100's of Hz) in byte 5, sent last.

All of the frequency data bytes (2 - 5) are encoded with the total byte value (both digits) simply the hex number with the same two digits as the corresponding two decimal digits of the frequency. Byte 2 represents the hundred's and ten's (MHz) decimal digits of the frequency, byte 3 the one's of MHz and hundred's of kHz, and byte 4 the ten's and one's of kHz. However, in byte 5, only the leftmost hex digit (high nibble) is used - for hundred's of Hz. The rightmost digit value is ignored, so use zero.

Note that the decimally converted hex value of each byte is not the same as the encoded value. For example, if byte 2 is 12H (hexadecimal), this represents a frequency of 120MHz, while the decimal conversion of 12H is actually $1 \times 16 + 2 \times 1$, or 18 decimal. Make sure this point is clear before attempting to write a program.

Example: To convert 65.4321 MHz into the proper byte code for sending to the receiver.

- (1) The 100's of MHz is zero, and the 10's of MHz is 6, so byte 2 is 06H. If you are setting a frequency below 100 MHz, don't forget to include the zero in the high nibble.
- (2) The 1's of MHz and 100's of kHz digits are 5 and 4, so byte 3 is 54H (which is actually $5 \times 16 + 4$, or 84 decimal: don't forget the encoding).
- (3) The 10's and 1's of kHz digits are 3 and 2, respectively, so byte 4 is just 32H (50 decimal).
- (4) Since the 100's of Hz digit is 1, byte 5 should be 10H (16 decimal), although any number between 10H and 19H would produce the same result, keeping the low nibble zero should make the programming easier to understand.

Since byte 1 is sent first, the command to send to set the FRG-9600 to 65.4321 MHz is, from left to right in the order of sending;

0AH 06H 54H 32H 10H

Notice that the alphabetic digits of base 16 numbers, "A" through "F", are never used in bytes 2 – 5 of frequency commands. Also, since the values of bytes 2 through 5 are only relevant to the frequency set command, they can be left unchanged (as "dummy" values) when sending mode commands. This can be used to advantage in programming.

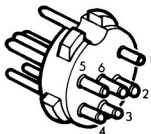

PIN 1: GND
2: N.C
3: SI (Serial In)
4: N.C
5: S-Meter
6: BUSY

CAT Plug

Mode Set Command

This command has six types, one for each mode. Only Instruction Byte 1 is significant (although four more bytes must be sent as dummies - their values are irrelevant). The Instruction Byte must be 10H (16 decimal) for LSB, 11H (17 decimal) for USB, 14H (20 decimal) for AM-N, 15H (21 decimal) for AM-W, 16H (22 decimal) for FM-N and 17H (23 decimal) for FM-W. Again, the value of bytes 2 - 5 don't matter, but they must still be sent.

CAT control programs can be written in most any computer language, as long as the time between sending bytes does not exceed the 200ms limit. In most cases the BASIC language will suffice. While it is not possible to give enough examples to cover all of the different dialects of BASIC, following are a few possible ways using general BASIC statements to send commands to the FRG-9600. They will need to be modified for different brands of computers.

The first example illustrates use of the BASIC "OUT" command for single byte "port poking". This technique requires that the hardware interface include a port address decoder and parallel-to-serial converter that has been preset for 4800 bits/sec.

```
REM   PTADDR = PORT ADDRESS OF SERIAL OUT

OUT(PTADDR), &H0A:
OUT(PTADDR), &H06:
OUT(PTADDR), &H54:
OUT(PTADDR), &H32:
OUT(PTADDR), &H10
```

Note that "&H" in the above example signifies for that BASIC that the following digits are a hexadecimal byte. In computers that do not have a hex number handling capability, the hex code must first be translated into decimal, in which case &H0A would be replaced with 10 (decimal), &H54 with 84 (decimal), &H32 with 50 (decimal), and &H10 with 16 (decimal). In either case the result of the command would be the same: to set the FRG-9600 to 65.4321 MHz.

Another way to send the same command, when using a computer that is equipped with an RS-232C serial port and the FIF-232C CAT Interface Unit, is shown below (this is for the Radio Shack Model 100, NEC PC-8201 or Olivetti M-10 portable computers);

```
10 OPEN "COM:7N82NN" FOR OUTPUT AS #1:
20 PRINT#1,CHR$(10) + CHR$(6) +
    CHR$(54) + CHR$(32) + CHR$(16);:
30 CLOSE#1
```

The result would be the same as in the previous example: set the FRG-9600 to 65.4321 MHz. However, in this case the decimal equivalents of the properly selected hex digits have been substituted in the arguments. Note that this conversion is only necessary if the computer cannot accept hex arguments in the CHR\$ command. If the conversion is necessary, make an array with the subscripts equal to the hex bytes and the contents equal to the associated decimal byte.

If the FRG-9600 is actively scanning frequencies via the internal scanner when the command is sent, it may be ignored. Internal scanning should be halted before external commands are sent (of course this does not affect scanning by your CAT program.

Using only the main CAT serial input command line you should have no trouble with simple programs, such as incorporating your own memory banks and blocks, referencing the frequencies to station call signs, and automatically selecting the most popularly used mode for each frequency range in your area.

When the S-meter and scan stop status lines in the CAT system are also used in programming, the external computer has some indication from the FRG-9600 of the results of commands it has issued: especially, whether or not a signal is present on the frequency, and how strong it is. This information can be used for programming just about any type of automatic scanning system, limited only by the imagination of the programmer.

CAT SYSTEM COMMAND CHART

Command		Byte Data					Function
		Inst*	Parameter Field				
byte no.		1	2	3	4	5	
Frequency set		0AH	NNH	NNH	NNH	NNH	see ** below
Mode Set:	LSB	10H	X***	X	X	X	Lower Sdbnd
	USB	11H	X	X	X	X	Upper Sdbnd
	AM-N	14H	X	X	X	X	AM Narrow
	AM-W	15H	X	X	X	X	AM Wide
	FM-N	16H	X	X	X	X	FM Narrow
	FM-W	17H	X	X	X	X	FM Wide

- * Instruction Byte sent first, determines nature of command
- ** "NNH" values are hexadecimal codes for frequency data, explained in the text.
- *** "X" signifies "dummy" byte: value unimportant, but must be sent to fill command to 5-byte format.

Memory Backup Information

Mode and frequency data is retained in the FRG-9600 by a lithium backup battery, which has an estimated lifetime of at least 5 years. During that time, if it is necessary or desirable to clear all of the stored data, use the following procedure (diagrams on next page).

- (1) Rotate the VOL control fully counterclockwise to switch off the receiver. Remove the power plug from the 13.8 VDC jack on the rear panel.
- (2) Remove the two screws on either side of the top cover, and carefully remove the cover by lifting the back edge slightly while sliding the cover toward the rear. It is necessary to slide the cover back about 1 cm to disengage

the internal spring clips before pulling the cover away (gradually, to avoid straining the speaker wires).

- (3) Locate the miniature (backup on/off) slide switch just behind the top right-hand corner of the front panel, and set this switch to the right. Wait about 30 seconds, and then return the switch to the left (if you want the memory backup feature on).
- (4) Replace the top cover by first sliding it from back to front so that the two mounting clips on the inside of the cover catch on the internal frame, and then replace the four screws. Reconnect the DC power plug.

If the memory backup feature begins to fail, see your dealer for installation of a replacement backup battery.

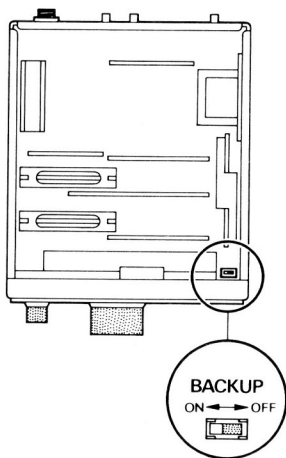
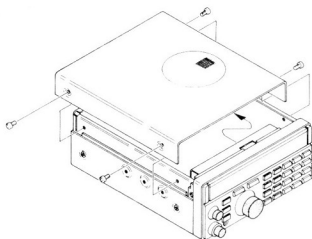



E1100185(8501-A)