

MT8801C
Radio Communication Analyzer
Options 10/11: Audio Test
Operation Manual

Third Edition

Read this manual before using the equipment.
Keep this manual with the equipment.

ANRITSU CORPORATION

Safety Symbols

To prevent the risk of personal injury or loss related to equipment malfunction, Anritsu Corporation uses the following safety symbols to indicate safety-related information. Insure that you clearly understand the meanings of the symbols **BEFORE** using the equipment. Some or all of the following five symbols may not be used on all Anritsu equipment. In addition, there may be other labels attached to products which are not shown in the diagrams in this manual.

Symbols used in manual

DANGER  This indicates a very dangerous procedure that could result in serious injury or death if not performed properly.

WARNING  This indicates a hazardous procedure that could result in serious injury or death if not performed properly.

CAUTION  This indicates a hazardous procedure or danger that could result in light-to-severe injury, or loss related to equipment malfunction, if proper precautions are not taken.

Safety Symbols Used on Equipment and in Manual

The following safety symbols are used inside or on the equipment near operation locations to provide information about safety items and operation precautions. Insure that you clearly understand the meanings of the symbols and take the necessary precautions **BEFORE** using the equipment.



This indicates a prohibited operation. The prohibited operation is indicated symbolically in or near the barred circle.



This indicates an obligatory safety precaution. The obligatory operation is indicated symbolically in or near the circle.



This indicates warning or caution. The contents are indicated symbolically in or near the triangle.



This indicates a note. The contents are described in the box.



These indicate that the marked part should be recycled.

MT8801C

Radio Communication Analyzer Options 10/11: Audio Test
Operation Manual

1 December 1999 (First Edition)

10 December 2003 (Third Edition)

Copyright © 1999-2003, ANRITSU CORPORATION.

All rights reserved. No part of this manual may be reproduced without the prior written permission of the publisher.

The contents of this manual may be changed without prior notice.

Printed in Japan

For Safety

WARNING



1. ALWAYS refer to the operation manual when working near locations at which the alert mark shown on the left is attached. If the operation, etc., is performed without heeding the advice in the operation manual, there is a risk of personal injury. In addition, the equipment performance may be reduced.

Moreover, this alert mark is sometimes used with other marks and descriptions indicating other dangers.

2. Measurement Categories

This instrument is designed for Measurement category I (CAT I). Don't use this instrument at the locations of measurement categories from CAT II to CAT IV.

In order to secure the safety of the user making measurements, IEC 61010 clarifies the range of use of instruments by classifying the location of measurement into measurement categories from I to IV.

The category outline is as follows:

Measurement category I (CAT I):

Secondary circuits of a device connected to an outlet via a power transformer etc.

Measurement category II (CAT II):

Primary circuits of a device with a power cord (portable tools, home appliance etc.) connected to an outlet.

Measurement category III (CAT III):

Primary circuits of a device (fixed equipment) to which power is directly supplied from the power distribution panel, and circuits from the distribution panel to outlets.

Measurement category IV (CAT IV):

All building service-line entrance circuits through the integrating wattmeter and primary circuit breaker (power distribution panel).



or



3. When supplying power to this equipment, connect the accessory 3-pin power cord to a grounded outlet. If a grounded outlet is not available, before supplying power to the equipment, use a conversion adapter and ground the green wire, or connect the frame ground on the rear panel of the equipment to ground. If power is supplied without grounding the equipment, there is a risk of receiving a severe or fatal electric shock.

For Safety

WARNING

Repair

WARNING 

4. This equipment cannot be repaired by the user. DO NOT attempt to open the cabinet or to disassemble internal parts. Only Anritsu-trained service personnel or staff from your sales representative with a knowledge of electrical fire and shock hazards should service this equipment. There are high-voltage parts in this equipment presenting a risk of severe injury or fatal electric shock to untrained personnel. In addition, there is a risk of damage to precision parts.

Falling Over

5. This equipment should be used in the correct position. If the cabinet is turned on its side, etc., it will be unstable and may be damaged if it falls over as a result of receiving a slight mechanical shock.
And also DO NOT use this equipment in the position where the power switch operation is difficult.

Battery Fluid

6. DO NOT short the battery terminals and never attempt to disassemble it or dispose of it in a fire. If the battery is damaged by any of these actions, the battery fluid may leak.
This fluid is poisonous.
DO NOT touch it, ingest it, or get in your eyes. If it is accidentally ingested, spit it out immediately, rinse your mouth with water and seek medical help. If it enters your eyes accidentally, do not rub your eyes, irrigate them with clean running water and seek medical help. If the liquid gets on your skin or clothes, wash it off carefully and thoroughly.

LCD

7. This instrument uses a Liquid Crystal Display (LCD); DO NOT subject the instrument to excessive force or drop it. If the LCD is subjected to strong mechanical shock, it may break and liquid may leak.
This liquid is very caustic and poisonous.
DO NOT touch it, ingest it, or get in your eyes. If it is ingested accidentally, spit it out immediately, rinse your mouth with water and seek medical help. If it enters your eyes accidentally, do not rub your eyes, irrigate them with clean running water and seek medical help. If the liquid gets on your skin or clothes, wash it off carefully and thoroughly.

For Safety

CAUTION

Replacing Fuse

CAUTION 

1. Before Replacing the fuses, ALWAYS remove the power cord from the poweroutlet and replace the blown fuses. ALWAYS use new fuses of the type and rating specified on the fuse marking on the rear panel of the cabinet.

T6.3A indicates a time-lag fuse.

There is risk of receiving a fatal electric shock if the fuses are replaced with the power cord connected.

Cleaning

2. Keep the power supply and cooling fan free of dust.
 - Clean the power inlet regularly. If dust accumulates around the power pins, there is a risk of fire.
 - Keep the cooling fan clean so that the ventilation holes are not obstructed. If the ventilation is obstructed, the cabinet may overheat and catch fire.

 CAUTION/注意

>18kg

HEAVY WEIGHT/重量物

3. Use two or more people to lift and move this equipment, or use a trolley. There is a risk of back injury, if this equipment is lifted by one person.

Check Terminal



4. Never input a signal of more than the specified voltage between the measured terminal and ground. Input of an excessive signal may damage the equipment.

5. Do not take out the floppy disk if the lamp of the floppy disk drive is on. If it is taken out, the contents of the storage medium will be damaged, resulting in floppy disk drive failure.

For Safety

CAUTION

Replacing Memory Back-up Battery

The power for memory back-up of the MT8801C is supplied by a polycarbomonofluoride lithium battery. this battery should only be replaced by a battery of the same type; since replacement can only be made by Anritsu, contact the nearest Anritsu representative when replacement is required. At the end of it's life, the battery should be recycled or disposed properly.

Note: The Battery life is about 7 years. Early battery replacement is recommended.

External Storage Media

The MT8801C stores data and programs using a floppy disk (FD), memory card (MC), and backed-up memories.

Data and programs may be lost due to improper use or failure.

Anritsu therefore recommends that you back up the memory.

ANRITSU CANNOT COMPENSATE FOR ANY MEMORY LOSS.

Please pay careful attention to the following points. Do not remove the floppy disk from the equipment being accessed.

(FD)

- Do not touch the FD directly or by using any object.
- Do not place the equipment where dirty and dusty.
- Isolate the FD and memory card from static electricity.
- Avoid to placing the FD in direct sunlight or near heating sources.
- Store under temperature of 40° to 54°C, humidity of 8 to 90% (No condensation).

(Memory card)

- Isolate the memory card from static electricity.

(Backed-up memory)

- Isolate the memory from static electricity.

Disposing of Product

The MT8801C uses chemical compound semiconductor including arsenic. At the end of its life, the MT8801C should be recycled or disposed properly according to the local disposal regulations.

Equipment Certificate

Anritsu Corporation certifies that this equipment was tested before shipment using calibrated measuring instruments with direct traceability to public testing organizations recognized by national research laboratories including the National Institute of Advanced Industrial Science and Technology, and the Communications Research Laboratory, and was found to meet the published specifications.

Anritsu Warranty

Anritsu Corporation will repair this equipment free-of-charge if a malfunction occurs within 1 year after shipment due to a manufacturing fault, provided that this warranty is rendered void under any or all of the following conditions.

- The fault is outside the scope of the warranty conditions described in the operation manual.
- The fault is due to mishandling, misuse, or unauthorized modification or repair of the equipment by the customer.
- The fault is due to severe usage clearly exceeding normal usage.
- The fault is due to improper or insufficient maintenance by the customer.
- The fault is due to natural disaster including fire, flooding, earthquake, etc.
- The fault is due to use of non-specified peripheral equipment, peripheral parts, consumables, etc.
- The fault is due to use of a non-specified power supply or in a non-specified installation location.

In addition, this warranty is valid only for the original equipment purchaser. It is not transferable if the equipment is resold.

Anritsu Corporation will not accept liability for equipment faults due to unforeseen and unusual circumstances, nor for faults due to mishandling by the customer.

Anritsu Corporation Contact

If this equipment develops a fault, contact Anritsu Service and Sales offices at the address at the end of paper-edition manual or the separate file of CD-edition manual.

Front Panel Power Switch

To prevent malfunction caused by accidental touching, the front power switch of this equipment turns on the power if it is pressed continuously for about one second in the standby state. If the switch is pressed continuously for one second in the power-on state, the equipment enters the standby state.

In the power-on state, if the power plug is removed from the outlet, then reinserted into it, the power will not be turned on. Also, if the lines is disconnected due to momentary power supply interruption or power failure, the power will not be turned on (enters the standby state) even if the line is recovered.

This is because this equipment enters the standby state and prevents incorrect data from being acquired when the line has to be disconnected and reconnected.

For example, if the data acquisition requires a long time at the BER measurement, momentary power supply interruption (power failure) might occur during measurement and the line could be recovered automatically to power-on. In such a case, the equipment may mistake incorrect data for correct data without recognizing the momentary power supply interruption.

If this equipment enters the standby state due to momentary power supply interruption or power failure, check the state of the measuring system and press the front power switch to restore power to this equipment.

Further, if this equipment is built into a system and the system power has to be disconnected then reconnected, the power for this equipment must also be restored by pressing the front power switch.

Consequently, if this equipment is built into remote monitoring systems that use MODEMs, the standby function of this equipment must be modified.

Trademark and Registered Trademark

[IBM] is a registered trademark of the IBM Corporation.

[HP] is a registered trademark of the Hewlett-Packard Company.

[MS-DOS] is a registered trademark of the Microsoft Corporation.

[NEC] is a registered trademark of the NEC Corporation.

CE Conformity marking

Anritsu affixes the CE Conformity marking on the following product (s) in accordance with the Council Directive 93/68/EEC to indicate that they conform with the EMC and LVD directive of the European Union (EU).

CE Marking



1. Product Model

Model: MT8801C Radio Communication Analyzer

2. Applied Directive

EMC: Council Directive 89/336/EEC

LVD: Council Directive 73/23/EEC

3. Applied Standards

- EMC: Emission: EN61326: 1997 / A2: 2001 (Class A)
Immunity: EN61326: 1997 / A2: 2001 (Annex A)

	Performance Criteria*
IEC 61000-4-2 (ESD)	B
IEC 61000-4-3 (EMF)	A
IEC 61000-4-4 (Burst)	B
IEC 61000-4-5 (Surge)	B
IEC 61000-4-6 (CRF)	A
IEC 61000-4-8 (RPFMF)	A
IEC 61000-4-11 (V dip/short)	B

*: Performance Criteria

A: During testing normal performance within the specification limits

B: During testing, temporary degradation, or loss of function or performance which is self-recovering

Harmonic current emissions:

EN61000-3-2: 2000 (Class A equipment)

- LVD: EN61010-1: 2001 (Pollution Degree 2)

C-tick Conformity marking

Anritsu affixes the C-tick marking on the following product (s) in accordance with the regulation to indicate that they conform with the EMC framework of Australia/New Zealand.

C-tick marking



1. Product Model

Model: MT8801C Radio Communication Analyzer

2. Applied Standards

EMC: Emission:
AS/NZS 2064.1 / 2 (ISM, Group 1, Class A equipment)

Power Line Fuse Protection

For safety, Anritsu products have either one or two fuses in the AC power lines as requested by the customer when ordering.

Single fuse: A fuse is inserted in one of the AC power lines.

Double fuse: A fuse is inserted in each of the AC power lines.

Example 1: An example of the single fuse is shown below:

Fuse Holder

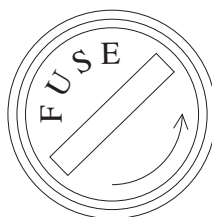

Example 2: An example of the double fuse is shown below:

Fuse Holders

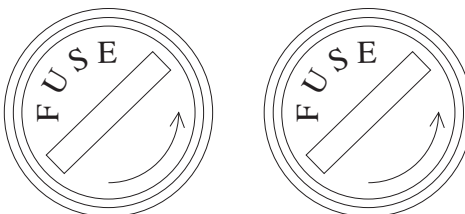

About This Manual

- (1) The explanations in this operation manual are based on the assumption that the MX880115A GSM Measurement Software (Ver. 3.03 or later) has been installed on the MT8801C Radio Communication Analyzer equipped with Option 01: Analog Measurement option.
- (2) Composition of this manual
This operation manual of the MT8801C Radio Communication Analyzer Options 10/11 consists of the following two parts.

Panel Operation: This part covers the outline of the MT8801C, preparation before use, panel explanation and operation.

Remote Control: This part covers the GPIB remote control.

This manual describes the Audio Test functions and operation of the GSM measurement software. For other functions and operations, refer to the MX880115A GSM Measurement Software operation manual (Ver. 3.03 or later) provided as a separate volume.

MT8801C
Radio Communication Analyzer
Option 10/11: Audio Test
Operation Manual
(Panel Operation)

Table of Contents

For Safety	iii
About This Manual	I
Section 1 General	1-1
1.1 General	1-2
1.2 Manual Composition	1-3
1.3 Equipment Configuration	1-4
1.4 Optional Accessories and Peripherals	1-5
1.5 Specifications	1-6
Section 2 Preparations Before Use	2-1
2.1 Installation Site and Environmental Conditions	2-2
2.2 Safety Measures	2-3
2.3 Preparations before Power-on	2-5
2.4 Installation	2-10
2.5 Precautions for Handling Storage Media	2-11
Section 3 Panel Layout and Overview of Operation	3-1
3.1 Panel Layout	3-2
3.2 Overview of Operation	3-7
Section 4 Operation	4-1
4.1 Turning on and off the Power	4-2
4.2 Screen Descriptions	4-7
4.3 Preparation	4-15
4.4 Setting Common Measurement Parameter — Setup Common Parameter screen	4-17
4.5 Transmission Audio Measurement — TX Audio screen	4-19

4.6	Reception Audio Measurement — RX Audio screen	4-21
4.7	Audio Echo Measurement — Audio Echo screen	4-23
4.8	Saving and recalling parameter data — Save Parameter screen, Recall Parameter screen	4-25
4.9	Operating the file — File Operation screen	4-30
4.10	Screen hard copy — Copy	4-34
4.11	Settings relating to remote control and panel key control	4-35
Section 5 Performance Tests		5-1
5.1	Requirement for Performance Tests	5-2
5.2	Instruments Required for Performance Test	5-2
5.3	Performance Tests	5-3
Section 6 Calibration		6-1
6.1	Calibration Requirements	6-2
6.2	Equipment Required for Calibration	6-2
6.3	Calibration	6-3
Section 7 Storage and Transportation		7-1
7.1	Cleaning the Cabinet	7-2
7.2	Storage Precautions	7-3
7.3	Repacking and Transportation	7-4
Appendix		App-1
	Appendix A Screen/ Function Key Change Figure	A-1
	Appendix B List of Initial Values	B-1
	Appendix C Index	C-1

Section 1 General

1.1	General	1-2
1.2	Manual Composition	1-3
1.3	Equipment Configuration	1-4
	1.3.1 Standard configuration	1-4
	1.3.2 Options	1-4
1.4	Optional Accessories and Peripherals	1-5
1.5	Specifications	1-6

1.1 General

The MT8801C Radio Communication Analyzer is a measuring-instrument platform that consists of the hardware components necessary for testing digital mobile telecommunication terminals. Using the MT8801C along with the optionally available measurement software allows you to evaluate the performance of mobile telecommunication equipment with efficiency.

The MT8801C equipped with Options 10/11 GSM Audio Test, can be used as an integrated measuring instrument for measuring the audio input/output performance of a radio conforming to the Full Rate Speech Transcoding recommended by GSM.

The Options 10/11 provide the following measurement functions.

- **Transmission measurement:** Audio signals sent by the radio under test can be measured.
- **Reception measurement:** Audio signals received by the radio under test can be measured.
- **Echo measurement:** The RF modulated signal sent by the radio under test is echoed back, and the audio signal received by the radio under test is measured.

This analyzer is equipped with a high-speed digital signal processing technology, allowing you to carry out transmission and reception measurements quickly and with high accuracy.

1.2 Manual Composition

This manual is made up of the following Sections.

Section 1 General

Describes the introduction, composition, function specifications and performance of this instrument.

Section 2 Preparations before Use

Explains various work to be performed before using this instrument.

Section 3 Panel Layout and Overview of Operation

Explains the basic items for operating this equipment.

Section 4 Operation

Explains basic operation and how to operate for each measurement item of options 10/11.

Section 5 Performance Test

Explains the performance test method of options 10/11 for this instrument.

Section 6 Calibration

Describes calibration items and methods for the periodical calibration of this equipment.

Section 7 Storage and Transportation

Describes how to store and transport this equipment.

Appendix A Screens and Function Key Transition Diagrams of options 10/11

Appendix B Initial Values of options 10/11

Appendix C Index

1.3 Equipment Configuration

This paragraph describes the configuration of the MT8801C Radio Communication Analyzer (with options 10/11) with standard accessories.

1.3.1 Standard configuration

The table below shows the configuration of the Options 10/11 of the MT8801C with the standard accessories.

Table 1-1 Standard Composition

Item	Order No.	Name	Qty	Remarks
Main instrument	MT8801C Options 10/11	Audio test	1	
Accessories	W1672AE	Operation manual	1	For options 10/11

1.3.2 Options

The table below shows the MT8801C options. These are sold separately.

Table 1-2 Options

Option No.	Name	Remarks
01	Analog measurement	
04	AF low impedance output	
07	Spectrum analyzer	
10, 11	GSM Audio Test	Option 01 is required.
12	CDMA measurement	Option 01 is required.

1.4 Optional Accessories and Peripherals

The following table shows the optional accessories and peripherals for the MT8801C which are all sold separately.

Table 1-3 Optional Accessories and Peripherals

<Optional accessories>

Model*/Order No.	Name*	Remarks
J0127C	Coaxial cord	BNC-P·RG-58A/U·BNC-P, 0.5 m
J0769	Coaxial adapter	BNC-J·TNC-P
J0040	Coaxial adapter	N-P·BNC-J
J0007	GPIB connection cable	408JE-101, 1 m
J0008	GPIB connection cable	408JE-102, 2 m
J0742A	RS-232C cable	1 m, D-sub 25pins, for PC-9800 Series personal computer of NEC Corp.
J0743A	RS-232C cable	1 m, D-sub 9pins, for IBM PC/AT personal computer
MN1607A	Coaxial switch	DC to 3 GHz, 50 Ω, externally controllable
MA1612A	4-Port junction pad	5 to 3000 MHz
J0395	Attenuator for high power	30 dB, 30 W, DC to 9 GHz
B0329D	Protective cover	
B0331D	Front handle kit	2 pcs/set
B0332	Coupling plate	4 pcs/set
B0333D	Rack mounting kit	
B0334D	Carrying case	With casters and protective cover

* Please specify the model/order number, name, and quantity when ordering.

<Peripherals and applicable units>

Model*/Order No.*	Name*
MS8604A	Digital mobile radio transmitter tester
MD1620B	Signaling tester (PDC)
MD1620C	Signaling tester (PHS)
MD6420A	Data transmission analyzer
MS2602A	Spectrum analyzer
MG3670B	Digital modulation signal generator

* Please specify the model/order number, name, and quantity when ordering.

1.5 Specifications

The MT8801C specifications are listed in Tables 1-4 and 1-5 below.

Table 1-4 MT8801C Specifications

General	Frequency range		300 kHz to 3 GHz
	Maximum input level		+40 dBm (10 W) (MAIN connector) +20 dBm (100 mW) (auxiliary input connector)
	Input/output connector	MAIN I/O connector	N-type connector Impedance 50 Ω, VSWR ≤ 1.2 (Frequency ≤ 2.2 GHz) VSWR ≤ 1.3 (Frequency > 2.2 GHz)
		Auxiliary input connector, Auxiliary output connector	TNC connector
	Reference oscillator	Frequency	10 MHz
		Starting characteristic	≤5 × 10 ⁻⁸ /day After 10 minutes of warm-up, referred to frequency after 24 hours of warm-up
Aging rate		≤2 × 10 ⁻⁸ /day ≤1 × 10 ⁻⁷ /year Referred to frequency after 24 hours of warm-up	
Temperature characteristic		5 × 10 ⁻⁸ (0 to 50°C) Referred to frequency at 25°C	
External standard input		10 MHz or 13 MHz (within ±1 ppm), Input level : 2 to 5 Vp-p	
Power meter	Frequency range		For CDMA measurement software : Only 1 channel of input code channel 824.04 to 848.97 MHz, 30 kHz step (IS-95A) 1850.00 to 1909.95 MHz, 50 kHz step (J-STD-008) 887.0125 to 888.9875 MHz, 898.0125 to 900.9875 MHz, 915.0125 to 924.9875 MHz, 12.5 kHz step (ARIB STD-T53) For other measurement software : 300 kHz to 3 GHz
	Level range		For CDMA measurement software : -10 to +40 dBm (MAIN connector) For other measurement software : 0 to +40 dBm (MAIN connector)
	Accuracy		For CDMA measurement software : ±10 % (18 to 28°C, -10 to +40 dBm, averaged, MAIN connector) (After zero-point calibration and at signal-generator output level equal to or less than -53 dBm) For other measurement software : ±10 % (0 to 50°C, 0 to +40 dBm, MAIN connector)
	Input connector		MAIN connector only
Signal generator	Frequency	Frequency range	10 MHz to 3 GHz
		Resolution	1 Hz
		Accuracy	Accuracy of reference frequency ±100 mHz
	Output level	Level range	-133 to -13 dBm (MAIN connector) -133 to +7 dBm (Auxiliary output connector)
		Level accuracy	±1 dB (≥-123 dBm, 18 to 28°C), ±3 dB (≥-133 dBm) (10 MHz ≤ Frequency ≤ 2.2 GHz) ±2 dB (≥-123 dBm, 18 to 28°C), ±4 dB (≥-133 dBm) (2.2 GHz < Frequency)
	Signal purity	Spurious	≤50 dBc (at CW), offset frequency : 100 kHz to 50 MHz Where, Carrier frequency : Other than 1300 MHz to 1400 MHz, and 2000 MHz to 2100 MHz ≤-40 dBc for all band
Harmonics		≤-25 dBc (at CW)	
Others	Display		Color TFT LCD display Size : 8.4 inches Number of dots : 640 × 480
	Hard copy		Enables data hard copy on the display through a parallel interface. (applicable only for EPSON VP-series or equivalent)
	External control	GPIO	Function : This equipment is specified as a device, can be controlled from external controller. (excluding power switch and FD ejection key) No controller function Interface function : SH1, AH1, T6, L4, SR1, RL1, PP0, DC1, DT1, C0, and E2
		Parallel	Function : Conforms to the Centronics. Outputs printing data to a printer. Data line exclusive for output: 8 Control line: 4 (BUSY, DTSB, ERROR, PE) Connectors : D-sub 25 pins, Female (Equivalent to the connector of IBM-PC/AT built-in printer)
RS-232C		Controlled from an external controller (except for the power switch) Baud rate : 1200, 2400, 4800, or 9600 bps	
Dimensions Mass Power supply	Dimensions		221.5 mm (H) × 426 mm (W) × 451 mm (D)
	Mass		≤27 kg (without any options)
	Power supply		100 to 120 V, 200 to 240 V 47.5 to 63 Hz, ≤300 VA Automatic voltage switch system
	Operating temperature range		0 to 50°C
EMC	Conducted Emission		EN61326: 1997 / A2: 2001
	Radiated Emission		EN61326: 1997 / A2: 2001
	Harmonic Current Emission		EN61000-3-2: 2000
	Electrostatic Discharge		EN61326: 1997 / A2: 2001
	Electromagnetic Field Immunity		EN61326: 1997 / A2: 2001
	Fast Transient / Burst		EN61326: 1997 / A2: 2001
	Surge		EN61326: 1997 / A2: 2001
	Conducted RF		EN61326: 1997 / A2: 2001
	Power Frequency Magnetic Field		EN61326: 1997 / A2: 2001
	Voltage Dips / Short Interruptions		EN61326: 1997 / A2: 2001

Table 1-5 Options 10/11: GSM Audio Test Specifications

Use:	Measuring the frequency and level of the audio signal that conforms to Full Rate Speech Transcoding recommended by GSM
Electrical characteristics:	The following specifications are guaranteed after the MT8801C internal level is optimized and level calibration (performed automatically when a key is pressed) is performed.
Transmission measurement:	RF modulated signal that conforms to the GSM specifications is demodulated and decoded, and the level and frequency of the decoded audio signal are measured.
Reception measurement:	RF modulated signal that conforms to the GSM specifications is sent, and the level and frequency of the audio signal from the radio under test are measured.

Transmission measurement	Decoding characteristics	Frequency range	50 Hz to 4 kHz
		Level range	0 to 3.2768 V
		Accuracy	± 1 Hz ($500 \text{ Hz} \leq \text{Frequency} \leq 2 \text{ kHz}$)
	AF oscillator	Frequency range	50 Hz to 20 kHz
		Frequency setting resolution	50 Hz
		Frequency accuracy	Synchronized with reference crystal oscillator
		Output level range	50 mVrms to 3 Vrms (EMF)
		Output level setting resolution	0.1 mV
		Output level accuracy	(Measured at < 30 kHz bandwidth) Unbalanced output : ± 0.5 dB Floating output : ± 2 dB (frequency = 1 kHz, output level ≥ 1 mV) Unbalanced output : ± 1 dB ($20 \text{ Hz} \leq \text{frequency} \leq 20 \text{ kHz}$, output level ≥ 1 mV)
		Output impedance	Main output : 600 Ω , unbalanced, BNC Microphone input : 600 Ω , Floating, DUT I/F
Waveform distortion	(Measured at < 30 kHz bandwidth) -50 dBc or less (frequency = 1 kHz, output level = 1 V) -45 dBc or less ($20 \text{ Hz} \leq \text{frequency} \leq 20 \text{ kHz}$, output level = 1 V)		
Reception measurement	Coded signal	Frequency setting range	50 Hz to 4 kHz
		Frequency setting resolution	50 Hz
		Level setting range	0 to 2.2 V
		Level setting resolution	0.1 mV
	AF level measurement	Frequency range	30 Hz to 20 kHz
		Level range	1 mVrms to 30 Vrms
		Accuracy	± 0.5 dB
	AF frequency measurement	Frequency range	30 Hz to 20 kHz
		Level range	30 mVrms to 30 Vrms
Accuracy		± 0.1 Hz	

Section 1 General

Section 2 Preparations Before Use

2.1	Installation Site and Environmental Conditions	2-2
2.2	Safety Measures	2-3
2.2.1	Safety measures for power supply	2-3
2.2.2	Maximum power to connector	2-4
2.3	Preparations before Power-on	2-5
2.3.1	Protective grounding	2-6
2.3.2	Replacing fuse	2-8
2.4	Installation	2-10
2.4.1	Rack mounting	2-10
2.4.2	Stacking	2-10
2.5	Precautions for Handling Storage Media	2-11
2.5.1	Floppy disk	2-11

2.1 Installation Site and Environmental Conditions

The MT8801C Radio Communication Analyzer operates normally at temperatures from 0 to 50 °C. However, for the best performance, the following locations should be avoided.

- Where there is severe vibration
- Where the humidity is high
- Where the equipment will be exposed to direct sunlight
- Where the equipment will be exposed to active gases

To insure long-term trouble-free operation, the equipment should be used at room temperature and in a location where the power supply voltage does not fluctuate greatly.

CAUTION

• **Prevention of failure due to condensation**

If the MT8801C is used at normal temperatures after it has been used or stored for a long time at low temperature, there is a risk of short-circuiting caused by condensation.

To prevent this risk, do not turn the power on until the MT8801C has been allowed to dry out sufficiently.

Fan clearance:

To suppress any internal temperature increase, the MT8801C has a fan on the rear panel as shown in the diagram below. Leave a gap of at least 10 cm between the rear panel and the wall, nearby equipment or obstructions so that fan ventilation is not blocked.

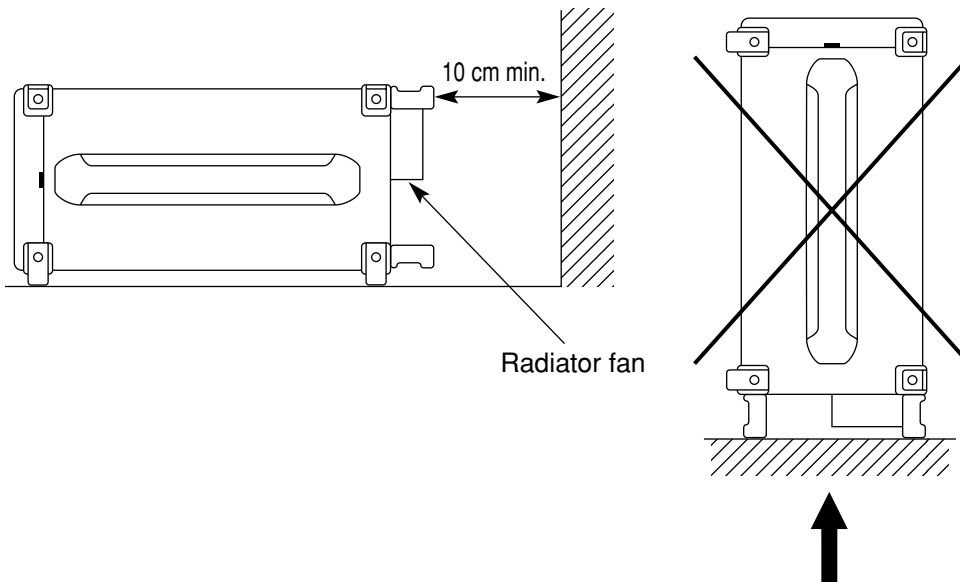

Do not use the equipment on its side.

2.2 Safety Measures

This paragraph explains the safety procedures which should be followed under all circumstances to counter the risk of an accidental electric shock, damage to the equipment or a major operation interruption.

2.2.1 Safety measures for power supply

WARNING

Before power-on:

- **Protective grounding**

The MT8801C must be connected to ground. If the power is turned on without taking this countermeasure, there is a risk of receiving an accidental electric shock.

- **Power supply voltage**

In addition, it is essential to check the power supply voltage. If an abnormal voltage that exceeds the specified value is input, there is an accidental risk of damage to the MT8801C and fire.

During power on:

- **To maintain the MT8801C, sometimes it is necessary to make internal checks and adjustments with the top, bottom or side covers removed while power is supplied. Very-high, dangerous voltages are used in the MT8801C; if insufficient care is taken, there is a risk of an accidental electric shock being received or of damage to the equipment. To maintain the MT8801C, request service by service personnel who has received the required training.**
-

In the following, special notes on safety procedures are explained for sections other than Section 2. To prevent accidents, read this section together with the related sections before beginning operation.

2.2.2 Maximum power to connector

The allowable maximum power to the MT8801C connectors are as follows.

Connector	Allowable maximum power
Main Input/Output	10 W (40 dBm)
AUX Input	100 mW (20 dBm)
AUX Output	Exclusive output connector, 0.5 mW (-3 dBm)
AF Input	30 Vrms
AF Output	Dedicated output connector, 6 Vrms (output impedance: 600 Ω), 0.6 Vrms (output impedance: 50 Ω)
DUT Interface	TTL level
Reference Input	2 to 5 Vp-p
10MHz Buffered Output	Dedicated output connector, TTL level
Detector Output	Dedicated output connector, TTL level
BER Input connectors	TTL level
Ext Trig Input	TTL level
Ext Trig Output	Dedicated output connector, TTL level
Ext FM Input	±10 Vp-p
Demod Output	Dedicated output connector, ±8 Vp-p

CAUTION

• **Excessive power protection**

Never apply power more than the allowable maximum power. Also, do not input external signal to the output connector.

2.3 Preparations before Power-on

The MT8801C operates normally when connected to 100 to 120 Vac, 47.5 to 63 Hz, or 200 to 240 Vac, 47.5 to 63 Hz AC power supply via the power inlet.

To prevent the following problems, take the necessary procedures described on the following pages before power is supplied.

- Accidental electric shock
- Damage caused by abnormal voltage
- Ground current problems

To protect the operator, the following WARNING and CAUTION notices are attached to the rear panel of the MT8801C.

WARNING 
NO OPERATOR SERVICE-
ABLE PARTS INSIDE.
REFER SERVICING TO
QUALIFIED PERSONNEL.

WARNING
Disassembly, adjustment, maintenance, or other access inside this instrument by unqualified personnel should be avoided. Maintenance of this instrument should be performed only by Anritsu trained service personnel who are familiar with the risks involved of fire and electric shock.

CAUTION 
FOR CONTINUED FIRE
PROTECTION REPLACE
ONLY WITH SPECIFIED
TYPE AND RATED FUSE.

CAUTION
Replace only with fuses of the specified type and rating. The use of improper fuses may cause fire.

2.3.1 Protective grounding

(1) Grounding with 3-pole power outlet

The power supply polarity of the 3-pole (grounded, 2-pole type) matches that of the 3-core power cord plug. Therefore, the MT8801C is connected to ground potential when the power cord is connected to the plug. As a result, it is not necessary to connect the FG terminal to ground.

(2) Grounding with conversion adapter

If a 3-pole power socket is not provided, use the 3-pole to 2-pole conversion adapter as shown in the figure below. Connect the green wire protruding from the 3 to 2 conversion adapter to ground.

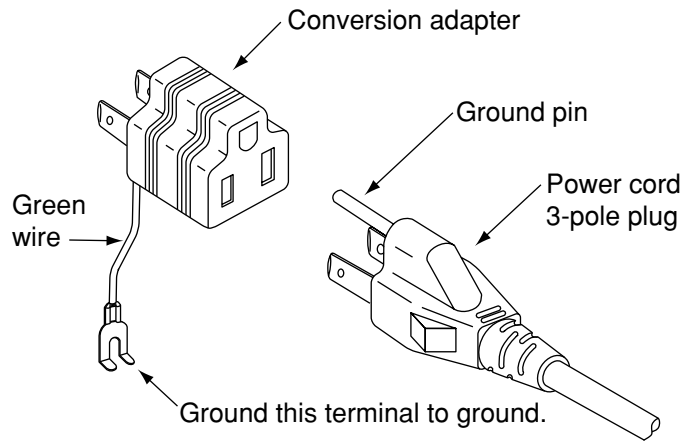

(3) Grounding with frame ground (FG) terminal

If a 3-pole ac power supply outlet is not available and the green wire cannot be grounded, the protective frame ground (FG) terminal on the rear panel must be connected directly to ground potential.

WARNING ⚠

• **Prevention of danger using protective ground terminal**
If power is supplied without protective grounding, there is a risk of accidental electric shock. If a 3-pole power supply outlet is not available and the green wire cannot be grounded, the protective frame-ground (FG) terminal on the rear panel must be connected to ground potential before power is supplied to the MT8801C.

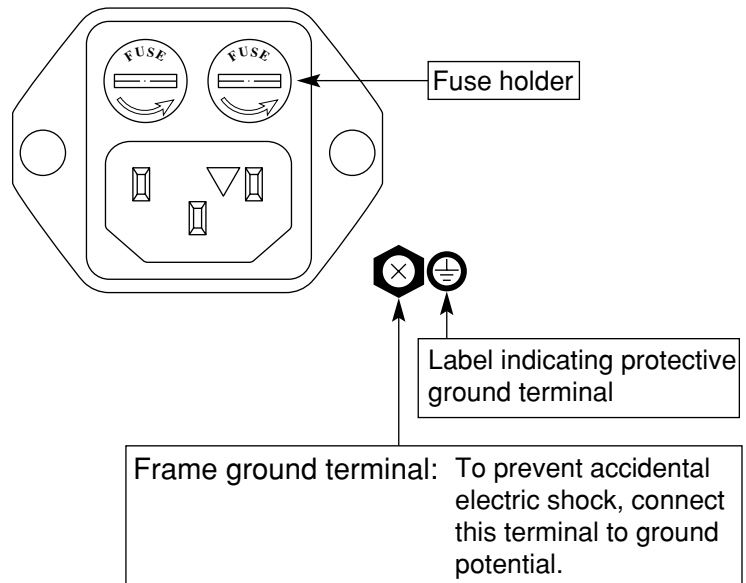

Section 2 Preparations Before Use

2.3.2 Replacing fuse

The MT8801C with standard accessories has two spare fuses (T6.3A250V). Use these fuses to replace the blown fuses. If the fuses must be replaced, locate and remedy the cause before replacing the blown fuses.

Power supply system	Voltage range	Fuse rating plate	Fuse rating	Fuse name	Model/Order No.
AC100 V	100 – 120V	T6.3A	6.3A, 250V	T6.3A 250V	F0014
AC200 V	200 – 240V	T6.3A			

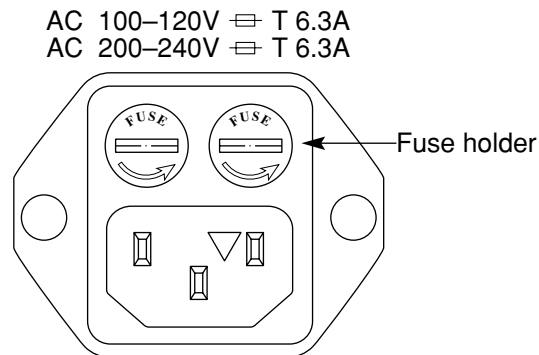

WARNING ⚠

- **Prevention of electric shock**
 Before replacing the fuses, turn the power switch off and remove the power cord from the power outlet. If the fuses are replaced while power is being supplied, there is a serious risk of electric shock.

- **Confirmation before turning the power on**
 After replacing fuses, the protective grounding mentioned above must be provided before turning the power on again, and the proper AC power supply voltage must be confirmed.
 If the AC power supply voltage is improper, there is a risk of the internal circuits of the MT8801C being damaged.

CAUTION **• Check on replacing fuses**

If the replacement fuses are not provided, obtain replacement fuses of the same rated voltage and current as the fuses in the fuse holders.

If the replacement fuses are not of the same type, they may not fit correctly, and failure will occur due to melting of the fuse.

When the rated voltage and current are over-sufficient, the fuses may not blow even if there is a risk of damage to the equipment by fire.

After performing the safety procedures, replace the fuses according to the following procedure.

Step	Procedure
1	Turn off the power switches on the front and rear panels, then remove the power cord from the power supply outlet.
2	Use a screwdriver to turn the fuse holder cap shown in the figure counterclockwise. The cap and fuse are removed together as a unit from the AC inlet.
3	Remove the fuse from the fuse cap and replace it with a spare fuse.
4	Return the fuse cap with the fuse to the fuse holder, then fasten it by turning it clockwise with the screwdriver.

* Contact the Anritsu service department for fuses by specifying the model name, order number, name, and quantity.

2.4 Installation

2.4.1 Rack mounting

The B0333D Rack Mounting Kit (sold separately, Table 1-3) is required to mount the MT8801C in a rack.

The installation method is included in the rack mount kit diagram.

2.4.2 Stacking

When stacking several MT8801Cs or stacking the MT8801C with equipment of the same width as the MT8801C, the B0332 Coupling Plate (sold separately, Table 1-3) are required.

2.5 Precautions for Handling Storage Media

2.5.1 Floppy disk

The following explains how to handle the floppy disk media of this instrument.

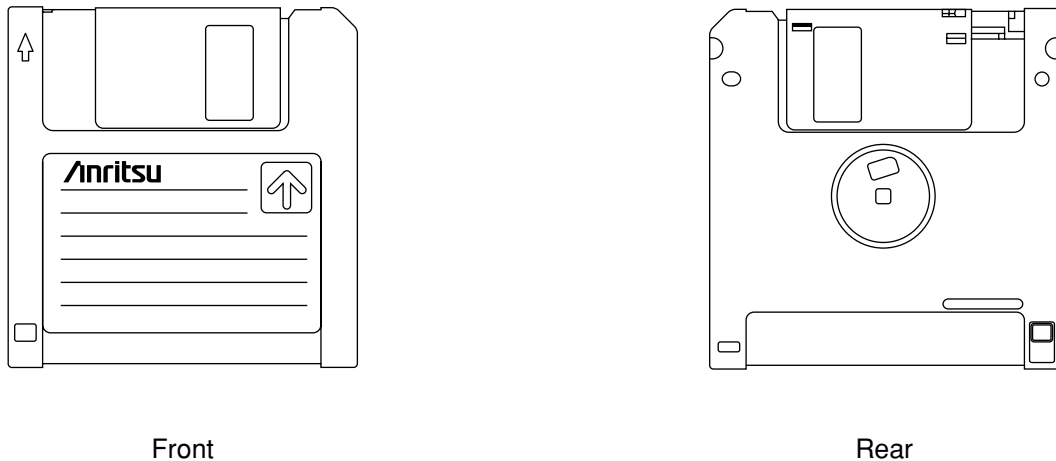

Fig. 2-1 3.5-inch Floppy Disk

(1) Precautions

The plastic case of the 3.5-inch floppy disk has a shutter to protect the disk inside. When the disk is inserted into the disk drive, the shutter opens to expose part of the disk. Do not touch the shutter.

The following care must be taken for handling the disk.

- (a) When a floppy disk is inserted, and the lamp on the disk drive lights, do not eject the disk. Otherwise, the memory contents may be damaged, resulting in disk drive failure.
- (b) Do not directly touch the magnetic surface with your hand or any object.
- (c) Do not expose the disk to dust.
- (d) Do not place the disk near any magnetic objects.
- (e) Do not place the disk in direct sunlight or near heater.
- (f) Store the disk under a temperature range of 4 to 53 °C and humidity of 8 to 90 % (no condensation).

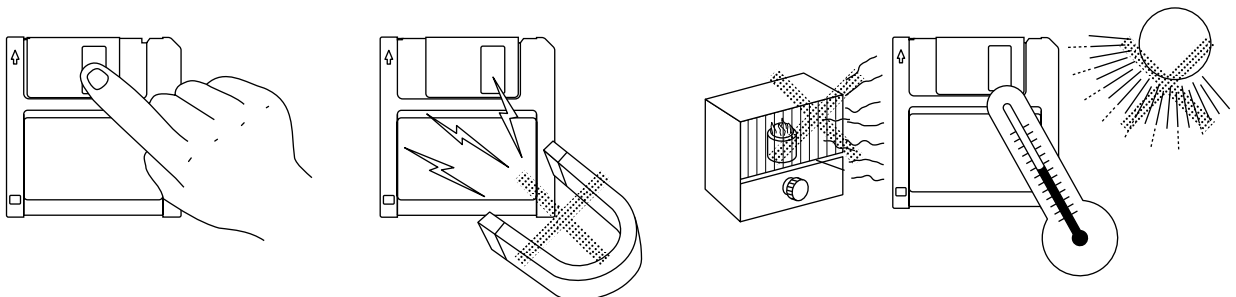

Section 2 Preparations Before Use

(2) Write-protection tab

A write-protection tab is provided on the 3.5-inch floppy disk. Sliding this tab downward in the arrow direction beforehand prevents accidental writing and deletion. (A write operation is disabled in this state.)

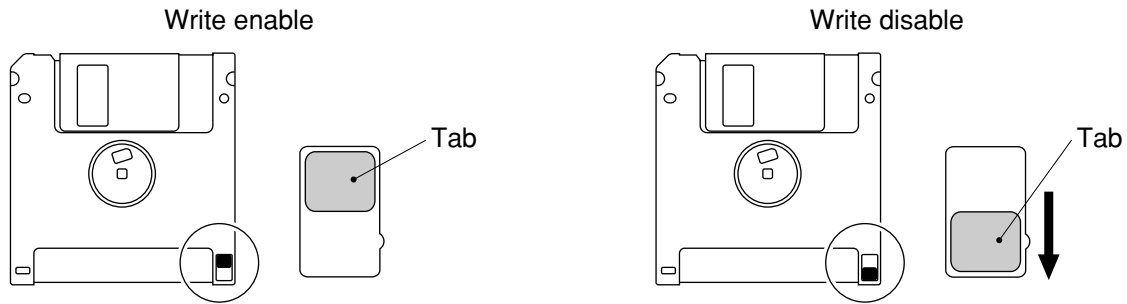

Fig. 2-2 Write-protection Tab for 3.5-inch Floppy Disk

(3) Inserting and ejecting the floppy disk

With the front surface of the floppy disk facing up, fully insert the disk in the arrow direction until a clicking sound is heard.

To eject, press the eject button on the right side of the disk drive. Remove the disk after confirming that the lamp is off.

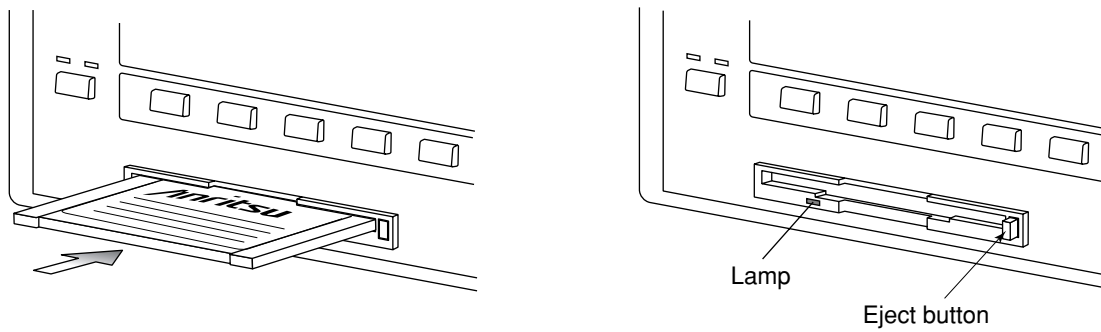

Fig. 2-3 Inserting and Ejecting the 3.5-inch Floppy Disk

Section 3 Panel Layout and Overview of Operation

3.1	Panel Layout	3-2
3.1.1	Front panel layout	3-2
3.1.2	Rear panel layout	3-5
3.1.3	Panel layout	3-6
3.2	Overview of Operation	3-7
3.2.1	Overview of functions	3-7
3.2.2	Overview of Operation	3-7

3.1 Panel Layout

This paragraph describes the keys, switches, lamps, and connectors on the front and rear panels of the MT8801C Radio Communication Analyzer.

3.1.1 Front panel layout

This paragraph describes the keys, switches, lamp, connectors, and the rotary knob on the front panel.

No.	Display	Function
1	F1,F2,F3,F4,F5,F6	Main function keys Group of keys that select and execute the corresponding menus displayed on the LCD screen. When the [Main Func] F6 key is on, the menus for F1 to F5 are placed in MT8801C measurement mode. When the [Main Func] F6 key is off, the menus of F1 to F5 are displayed for the currently used screen function.
2	F7,F8,F9,F10,F11,F12	Function keys Group of keys that select and execute the corresponding menus displayed on the LCD screen. These screen functions are related to the current operation.
3	Next Menu ▲ ◀	Displays the next page of the function key menu. Displays the next page of the main function key menu.

No.	Display	Function outline
4		Key group for entering data.
	Shift	Switches the function of keys with a shift function. When the shift key is pressed, the key's lamp goes on. Subsequent operation must be started with this lamp on.
	BS	Back space key used to correct input data.
	0,.,-/+ ,1,2,3, A/4,B/5,C/6,D/7,E/8,F/9	Numeric keys (ten-keypad) used for data input. These keys become alphanumeric keys at shift function activation.
	(Definition key group)	The data input using the numeric keys is defined with these keys.
	W/GHz/dBm/dB	Validates data when W/GHz/dBm/dB unit system data is input.
	mW/MHz/dBμ/sec	Validates data when mW/MHz/dBμ/sec unit system data is input.
	μW/kHz/mV/ms	Validates data when μW/kHz/mV/ms unit system data is input.
	nW/Hz/μV/μs/Enter	Validates data when nW/Hz/μV/μs unit system data or non-unit system data is input.
5	Measure	Key group used to start measurement.
	Single	Key used to execute measurement once.
	Continuous	Key used to execute measurement continuously.
6	Copy	Outputs display screen to the specified printer. (Hard copy function)
7	Cursor	Key group used to control the cursor on the LCD screen.
	Set	Opens the input window for data in the item pointed to by the cursor. After the completion of data entry, the window is closed.
	Cancel	Closes the window. The input data becomes invalid.
	∧ < > ∨	Moves the cursor.
8	Step	Key group increment or decrement numeric data.
	∧	Increments numeric data by the specified step value.
	∨	Decrements numeric data by the specified step value.
		Entry using these keys is always validated every time the data incremented or decremented.
9	(Rotary knob)	Knob used for data input. When this knob is turned clockwise, the value increases and when it is turned counterclockwise, the value decreases. For input by the rotary knob, data is validated each time it is incremented/decremented. This knob is also used in item selection.

Section 3 Panel Layout and Overview of Operation

No.	Display	Function outline
10	Main Input/Output	Input/output connector for RF signal. (N type connector)
11	AUX	Auxiliary input/output connectors for RF signal. (TNC connector)
	Input	Auxiliary input connector for RF signal. This is used when the output level of DUT is too low.
	Output	Auxiliary output connector for RF signal. This is used when the sensitivity of DUT is too low.
12	AF Input	AF signal input connector for Option 01(Analog) and Options 10, 11 (GSM Audio Test), (BNC connector)
	AF Output	AF signal output connector for Option 01(Analog) and Options 10, 11 (GSM Audio Test), (BNC connector)
13	DUT Interface	Multi-pole connector used to control the DUT and measure the BER (D-SUB connector, 25-pin, female).
14	(Floppy disk drive)	Slot in which the floppy disk is loaded for saving and recalling data, and loading system program.
15	Stby On	Change-over switch to turn the standby power supply on when the Line Input on/off switch on the rear of this instrument is turned on. In Standby mode, power is only supplied to the reference crystal oscillator.
16	Panel Lock	Invalidates all key operations except the Panel Lock key and the Stby On power supply switch on the front panel. In lock mode, the lamp on this key goes on.
17	Remote Local	Resets GPIB remote mode and returns to local mode. In GPIB remote mode, the lamp (Remote) goes on.
18	Preset	Initializes measurement parameters.

3.1.2 Rear panel layout

This paragraph describes the switch and connectors on the rear panel.

No.	Display	Function
19	O I	Input switch for AC power supply. If this switch is turned off, the Power switch on the front panel cannot be turned on.
20	(Fuses)	Power supply fuses. For safety, always use fuses of the specified rating.
21		Frame grounding terminal. For safety, always ground this terminal.
22	(Memory card cover)	The memory card is built-in. Close the cover for card use.
23	(Power supply inlet)	For safety, always use a power supply of the rated voltage.
24	GPIB	GPIB interface connector.
25	Parallel	Parallel interface connector (conforms to Centronics type). Used to connect printer (D-SUB connector, 25-pin, female).
26	Serial	RS232C interface connector (D-SUB connector, 9-pin, female).
27	10MHz Buffered Output	10 MHz reference signal (TTL level) for internal use is output (BNC connector).
28	10MHz/13MHz Reference Input	10 MHz or 13 MHz reference signal (2 to 5 Vp-p) is input (BNC connector).
29	Detector Output	RF burst signal detection output connector (BNC connector).
30	BER Input	Signal input connectors for measuring bit error rate (BNC connector).
	Data	Input connector for measurement data of bit error rate (BNC connector). TTL level signal is input.
	Clock	Input connector for clock of bit error rate (BNC connector). TTL level signal is input.
31	Ext FM Input	External FM modulation signal input connector for Option 01(Analog), (BNC connector)
32	Demod Output	FM demodulated signal output connector for Option 01(Analog), (BNC connector)
33	Ext Trig Input	Input connector for external trigger signal (BNC connector). TTL level signal is input.
35	(Fan)	Instrument internal air cooling fan.
36	CDMA Reference Input	Input connector for CDMA clock signal (BNC connector). TTL level signal is input.
37	CDMA Reference Output	Output connector for CDMA clock signal (BNC connector). TTL level signal is output.
38	CDMA Timing	Connector for CDMA timing (D-SUB25 connector, 25 pins, female).

Section 3 Panel Layout and Overview of Operation

3.1.3 Panel layout

The front panel and rear panel layouts are shown in Figs. 3-1 and 3-2, respectively. The numbers in the diagram correspond to those in paragraphs 3.1.1 and 3.1.2.

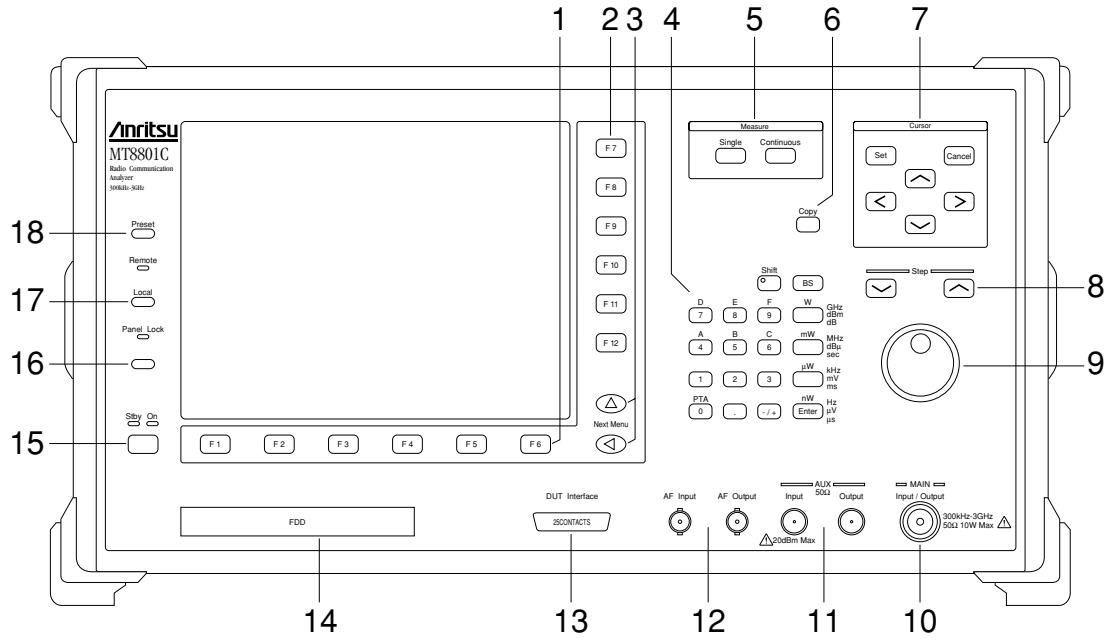

Fig. 3-1 Front Panel

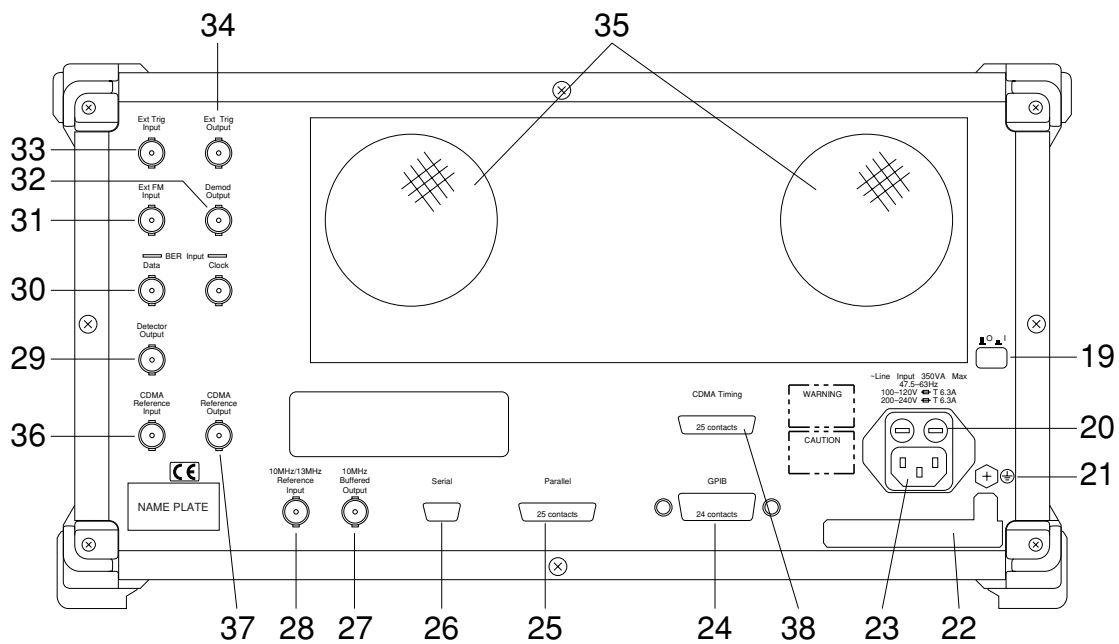

Fig. 3-2 Rear Panel

3.2 Overview of Operation

3.2.1 Overview of functions

The options 10/11: GSM Audio Test of the MT8801C Radio Communication Analyzer can be used to measure the audio input/output performance of a radio that conforms to Full Rate Speech Transcoding recommended by GSM.

The following measurements can be performed by using the function menu displayed on the screen.

1. Transmission audio (TX Audio) measurement

AF signal from the MT8801C is audio-encoded, and the RF signal is modulated by the audio-encoded signal in the radio under test. The modulated RF signal is received, demodulated, and decoded by the MT8801C; and the frequency and level of the AF signal decoded are measured.

2. Reception audio (RX Audio) measurement

RF modulated signal from the MT8801C is received, demodulated, and audio-decoded in the radio under test. The audio signal decoded is inputted to the MT8801C to measure the frequency and level of the fundamental component of the audio signal.

3. Audio echo measurement

AF signal outputted from the MT8801C is encoded, and the RF signal is modulated by the audio-encoded signal in the radio under test.

The sent data in the RF signal of the radio is echoed back from the MT8801C to the radio, and the level and frequency of the demodulated/audio-decoded audio signal of the radio are measured by the MT8801C.

3.2.2 Overview of Operation

(1) Selection of GSM audio test mode

Press the [Main Func On/Off] F6 key to turn on the main menu. The 1st page of the main menu is displayed at the bottom of the screen, horizontally. Press [TX/RX Tester] F1 key on this screen. Next, press [Audio Test] F4 key to select the GSM Audio Test mode.

(2) Selection of measurement items

Items are set by using cursor keys ([\wedge], [\vee], [$<$], [$>$]), and other function keys while observing the screen menu.

(3) Item input

For selection items displayed:

Select the required value by using the cursor keys or rotary knob.

For numeric values: Input data using the numeric keys, and validate by pressing a unit key, [Enter] key, or [Set] key. The window closes.

Section 3 Panel Layout and Overview of Operation

(4) Outline of screen configuration

The screen configuration is shown below. A tree-shaped Hierarchical configuration of items below the main menu is indicated. (Details of operation are explained in Section 4. The screens, setup items and function key flowchart for each screen are summarized in Appendix A, “Screen and Function Key Transition Diagrams.”)

[Overview of screens]

- TX & RX Tester mode
 - └ Setup Common Parameter screen
(TX/RX common measurement condition set screen)
 - └ TX Measure mode
 - └ Setup TX Measure Parameter screen
(TX measurement condition set screen)
 - └ Select All Measure Item screen
(TX all measured-value list item set screen)
 - └ All Measure screen
(TX all measured-value list measurement screen)
 - └ Modulation Analysis screen
(TX modulation analysis screen — numeric display)
 - └ Constellation, EyeDiagram, Phase Error, Magnitude screen
(TX modulation analysis screen — 4-waveform display)
 - └ RF Power screen
(TX RF power (burst amplitude) measurement screen)
 - └ Setup Template screen
(Template set screen)
 - └ Output RF Spectrum screen
(RF output spectrum measurement screen)
 - └ Power Meter screen
(TX RF power (averaged value) measurement screen)
 - └ RX Measure mode
 - └ Setup RX Measure Parameter screen
(RX measurement condition set screen)
 - └ Bit Error Rate screen
(RX bit-error-rate (BER) measurement screen)
 - └ Call Processing mode
 - └ Setup Call Processing Parameter screen (Call-processing test condition set screen)
 - └ Sequence Monitor screen (Call-processing operation state display screen)
 - └ Audio Echo mode
 - └ Tx Audio screen
 - └ Rx Audio screen
 - └ Audio Echo screen

- Recall mode
 - └ Recall Parameter screen
(Screen for recalling parameter-file)

- Save mode
 - └ Save Parameter screen
(Screen for saving parameter-file)

- File Operation mode
 - └ File Operation screen
(Screen for file retrieval/deletion/protection-setup in FD, and FD initialization)

- Change System mode
 - └ Change System screen
(Screen for changing TX & RX Tester mode measurement system)

- Instrument Setup mode
 - └ Instrument Setup screen
(Screen for setting up RS232C/GPIB, etc. for MT8801C main frame)

Note:

Change Color mode (Selection for screen display color) is setup using the function key menu. There is no screen in Change Color mode.

Section 3 Panel Layout and Overview of Operation

Section 4 Operation

Describes the operation of the Option 10/11 Audio Test of the MT8801C Radio Communication Analyzer.

4.1	Turning on and off the Power	4-2
4.2	Screen Descriptions	4-7
4.3	Preparation	4-15
4.4	Setting Common Measurement Parameter — Setup Common Parameter screen	4-17
4.5	Transmission Audio Measurement — TX Audio screen	4-19
4.5.1	Timing of transmission audio measurement	4-20
4.6	Reception Audio Measurement — RX Audio screen	4-21
4.6.1	Timing of reception audio measurement	4-22
4.7	Audio Echo Measurement — Audio Echo screen	4-23
4.7.1	Timing of audio echo measurement	4-24
4.8	Saving and recalling parameter data — Save Parameter screen, Recall Parameter screen	4-25
4.9	Operating the file — File Operation screen	4-30
4.10	Screen hard copy — Copy	4-34
4.11	Settings relating to remote control and panel key control	4-35

4.1 Turning on and off the Power

The MT8801C has two power switches: The Stby/On switch on the front panel and  (main power) switch on the rear panel.

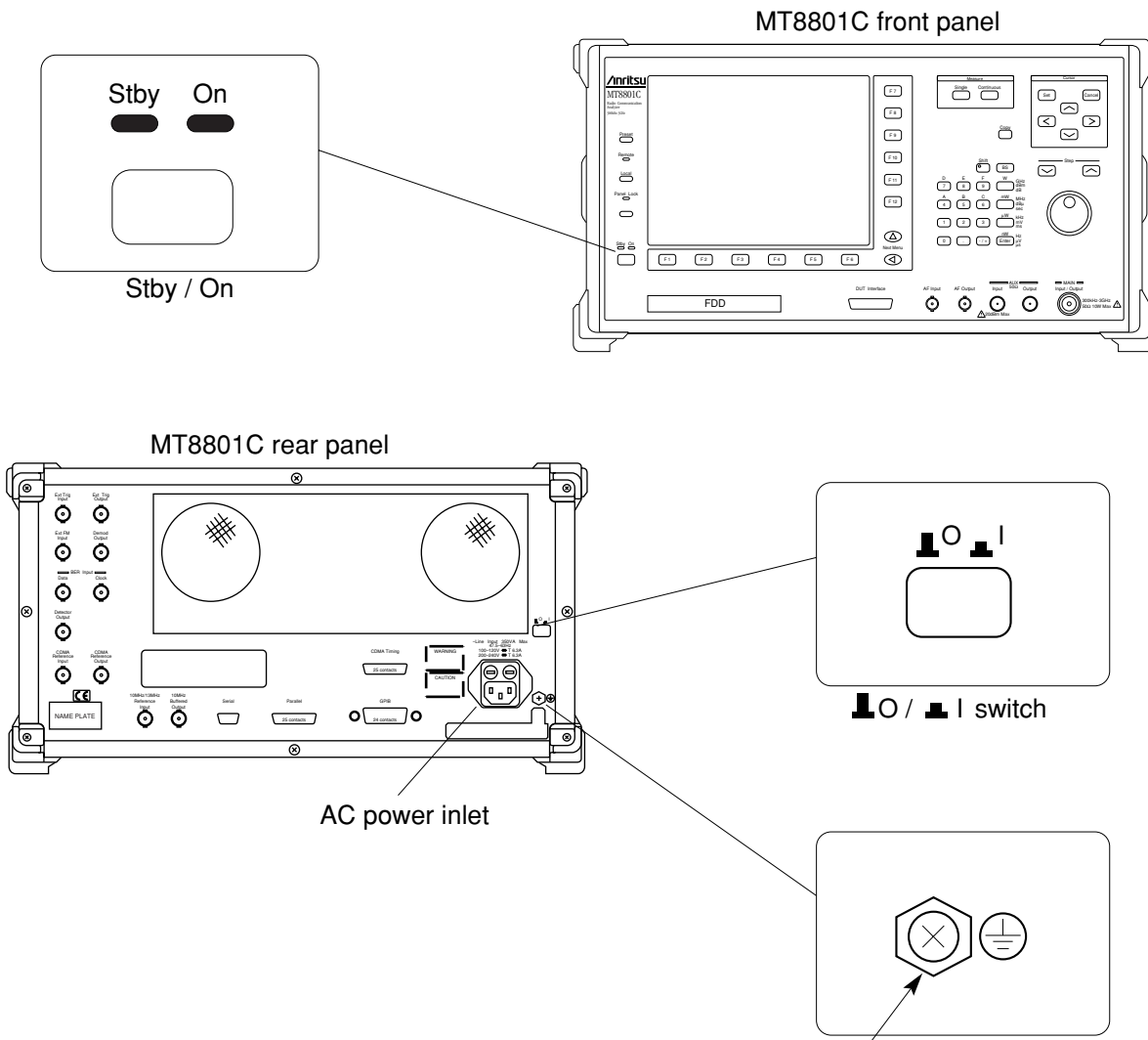

Frame grounding terminal: Connect this terminal to ground to prevent electric shock.

WARNING

• **Protective grounding**
If the power is turned on without protective grounding, operator runs the risk of electric shock. If the MT8801C does not have a three-pole (grounding type two-pole) power outlet, be sure to connect the frame grounding (FG) terminal on the rear panel or ground terminal of the accessory power cable to ground before turning on the MT8801C power.

CAUTION • **Checking the power supply voltage**

If the AC power supply voltage is improper, abnormal voltage may damage the mechanism inside the equipment. Confirm that the AC power supply voltage is within the specified rating before turning on the MT8801C power.

The following shows the specified power supply voltage and frequency:

Voltage: 100 to 120 Vac or 200 to 240 Vac (Because an automatic input voltage rating switching system is used, the rating need not be switched.)

Frequency: 47 to 63 Hz

For normal MT8801C operation, leave the power switch on the rear panel set to on when the AC power inlet is connected to the power outlet, and only use the Stby/On switch on the front panel to turn the power on and off.

Check the power display lamps at the lower-left part of the front panel as listed in the table below to confirm the power supply state.

Table 4-1 Power Display Lamp Indications and Power Supply States

Display lamp State	Power standby display lamp (green) (Stby)	Power on display lamp (orange) (On)
Main power off	Off	Off
Only main power on	On	Off
All power supplies on	Off	On

Section 4 Operation

4.1.1 Turning on the Power

Perform the power-on procedure through warming up the internal reference oscillator to normal MT8801C operation in order of the following steps:

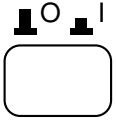
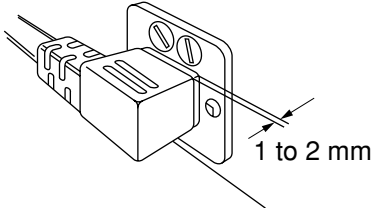
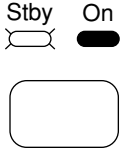
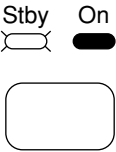
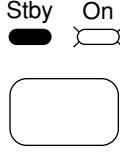
Step	Operation	Description										
1	Connect the frame grounding terminal on the rear panel to ground.	When using a three-pole power cable with a grounding terminal, the MT8801C need not be grounded.										
2	 Set the O I switch on the rear panel to O (Off).	When the button is pressed down and set, it is I (On). Press the button again to release it. When the button is set Off, the AC power is turned off even if the power switch on the front panel is set On.										
3	Connect the power cable jack to the AC power inlet on the rear panel.	Fully insert the power cable jack so that there is a gap of 1 to 2 mm as shown in the figure at right. 										
4	Connect the power cable plug to the AC power outlet.											
5	Set the O I switch on the rear panel to I (On).	The Stby lamp on the front panel power switch lights. 										
		The reference crystal oscillator circuit built in the MT8801C starts to warmed up. Before operating the MT8801C under low temperatures, warm up the crystal oscillator for 24 hours. The table below lists the stability of the crystal oscillator based on the warm-up time. <table border="1" style="margin: 10px auto;"> <thead> <tr> <th colspan="2">Item</th> <th>Stability</th> </tr> </thead> <tbody> <tr> <td>Starting characteristics</td> <td>After 30-minute operation</td> <td>5×10^{-8}/day or less</td> </tr> <tr> <td colspan="2">Aging rate (after 24-hour operation)</td> <td>2×10^{-8}/day or less</td> </tr> <tr> <td colspan="2">Stability at ambient temperature change of crystal oscillator ($25^{\circ}\text{C} \pm 25^{\circ}\text{C}$)</td> <td>$\pm 5 \times 10^{-8}$ or less</td> </tr> </tbody> </table>	Item		Stability	Starting characteristics	After 30-minute operation	5×10^{-8} /day or less	Aging rate (after 24-hour operation)		2×10^{-8} /day or less	Stability at ambient temperature change of crystal oscillator ($25^{\circ}\text{C} \pm 25^{\circ}\text{C}$)
Item		Stability										
Starting characteristics	After 30-minute operation	5×10^{-8} /day or less										
Aging rate (after 24-hour operation)		2×10^{-8} /day or less										
Stability at ambient temperature change of crystal oscillator ($25^{\circ}\text{C} \pm 25^{\circ}\text{C}$)		$\pm 5 \times 10^{-8}$ or less										
6	 Hold down the Stby/On switch on the front panel for a few seconds to set it On.	The On lamp on the front panel power switch lights and the Stby lamp goes off. 										
		Power is supplied to all circuits in the MT8801C, then the MT8801C becomes operable.										

Notes:

If neither power display lamp lights, check the following:

1. Are the power cables properly connected to the power inlet and power plug?
2. Are the specified fuses set in the fuse holders?
3. Is the power supply voltage correct?

Notes:

The below figure shows the reference signal input/output connectors on the MT8801C rear panel. The internal 10 MHz reference signal is output from the 10 MHz OUTPUT connector at TTL level. When the internal reference signal is not used, input an external reference signal satisfying the following conditions to the 10 MHz/13 MHz Reference Input connector:

- i) Frequency: 10 MHz \pm 1 ppm, signal level: 2 to 5 Vp-p
- ii) Frequency: 13 MHz \pm 1 ppm, signal level: 2 to 5 Vp-p

Set the reference frequency on the Instrument Setup screen (see paragraph 4.3.6 of Option 01: Analog Measurement) according to the external reference signal used as described in i) and ii) above.

Warm up the external reference signal equipment separately from warming up the MT8801C.

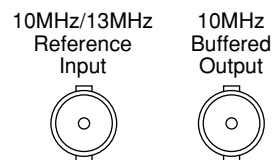

Section 4 Operation

4.1.2 Turning off the Power

Turn off the power as described below.

(1) Normal power-off procedures

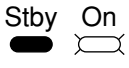
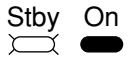
Step	Operation	Result check
1	 Press the Stby/On switch on the front panel for a few seconds to set it to Stby state.	<ul style="list-style-type: none"> The On lamp of the Power switch on the front panel goes off, and the Stby lamp lights. Only the internal reference crystal oscillator is turned on. 

(2) Power-off procedures for storage or long stop

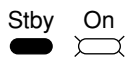
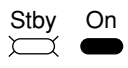
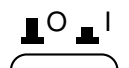
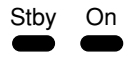
Step	Operation	Result check
1	 Press the Stby/On switch on the front panel for a few seconds to set it to Stby state.	<ul style="list-style-type: none"> The On lamp of the power switch on the front panel goes off and the Stby lamp lights. Only the internal reference crystal oscillator is turned on. 
2	 Set the O I switch on the rear panel to the I (off) position.	<ul style="list-style-type: none"> The AC power is turned off. Both the Stby and On lamps of the Power switch on the front panel go off. Only the internal reference crystal oscillator is turned on. 

4.1.3 Setup state after power-on

- The Setup Common Parameter screen is displayed shortly after power-on. At this time, parameters can be set by specifying Power-On Initial on the Instrument Setup screen.(See paragraph 4.3.6. of Option 01: Analog Measurement)
- If a short power failure occurs, the power switch on the front panel goes Off. In this case, press the power switch On again.

4.2 Screen Descriptions

This paragraph describes the common items displayed on the screen.

4.2.1 Screen layout

The composition of the measurement screen is described below.

(1) Title display area

The type MT8801C, and date (**_**_**) time (**:**:**), or user-defined character string (title) are displayed on the top left line. These are set on the Instrument Setup Screen.

(2) Screen name display area

The screen name (paragraph 3.2.2 (4)) and measurement system name are displayed on the second line from the top left.

(3) Measurement error messages display area

Messages for errors generated during measurement are reverse displayed on the third line from the top left.

There are 7 measurement error messages as follows. Messages are shown in high priority order.

[RF measurement]

Priority

High	Input Level Over	RF input level exceeded the hardware limit.
↑	Level Over	Level too high
↓	Level Under	Level too low
Low	Deviation under	Deviation too small

[AF measurement]

High	Input Level Over	AF input level exceeded the hardware limit
↑	Level Over	AF level too high
↓	Level Under	AF level too low

(4) RF input/output display

“M” or “A” displayed on the first line from the top center indicates the RF connector used.

M: Main Input/Output

A: AUX Input/Output

(5) Calibrated display

If the MT8801C is already calibrated, “C” is displayed on the second line from the top center.

This is appeared after executing calibration in the RF Level/Power on the TX Measure screen.

C: Calibrated

(6) User calibration factor setting display

If a user calibration coefficient is being set, “U” is displayed on the third line from the top center.

This is appeared when the user Cal. factor is set at the Setup TX Measure Parameter Screen.

U: User Cal. Factor

(7) Measurement mode display area

The measurement mode is displayed on the first line from the top center.

This is appeared depending on the Measure key (Continuous/Single).

Measure: Continuous: Continuous measurement

Measure: Single: Single (one time) measurement

(8) Storage mode display area

The displayed value or waveform storage mode is displayed on the second line from the top right.

This is the setting value of the storage mode on the current measurement screen.

Storage:

Normal: Normal display

Average : Averaging

(order of storage operations performed and total number of operations)

(9) Menu display area

The titles of up to six main function keys (F1 to F6) are displayed horizontally along the bottom.

When the [Main Func on off] (F6) key on the right is set On, the main function menu is displayed.

When the [Main Func on off] (F6) key is set Off, the menu is displayed according to the screen contents.

Use the Next Menu [◀] key to display the next page.

The display of 1 (first page), 2 (second page), or later above the F6 menu indicates the current page.

The titles of up to six function keys (F7 to F12) are displayed vertically along the right side.

The display of 1 (first page), 2 (second page), or later under function key F12 indicates the menu page number.

The current page is reverse displayed. If there are multiple pages, use the Next Menu [▶] key to display the next page under the F12 key.

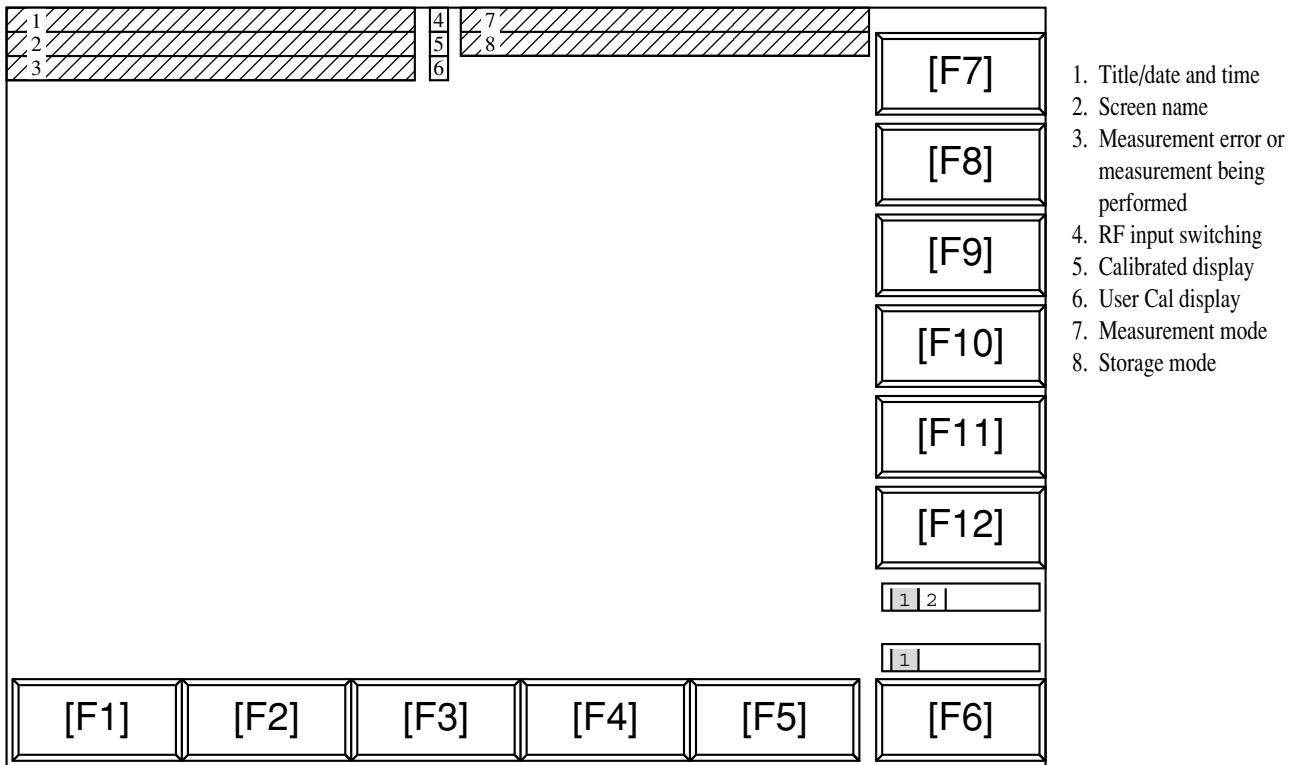

Fig. 4-1 Screen Layout

4.2.2 Function keys

The symbols displayed on the top right of the function keys indicate the following functions:

- * : Indicates a lower level function key is displayed when this function key is pressed.
- : Indicates the screen is changed by pressing this function key.
- # : Indicates a window is opened to set a value using the ten-keypad, Step key, or rotary knob when this function key is pressed.

(1) Menu for transition to lower hierarchy screen

(The Back screen key switches the current screen to the higher hierarchy screen.)

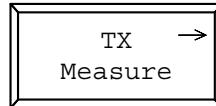

(2) Menu for transition to lower hierarchy menu



(3) Menu for opening the value setting window

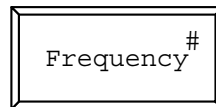

- Function key menu that select setting item:
One of the multiple selection keys (displayed in the same menu hierarchy) can be selected. The top and right frames of the selected key are reverse displayed. (See para. (5) below.)
The setting values displayed in a key are changed alternately. When such a key is selected, the set value is reverse displayed. (See para. (4) below.)

(4) Menu on which set items are switched alternately (alternate key menu)

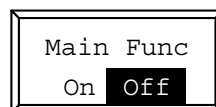

(5) Menu on which a set item is selected

[Example of the function key menu]

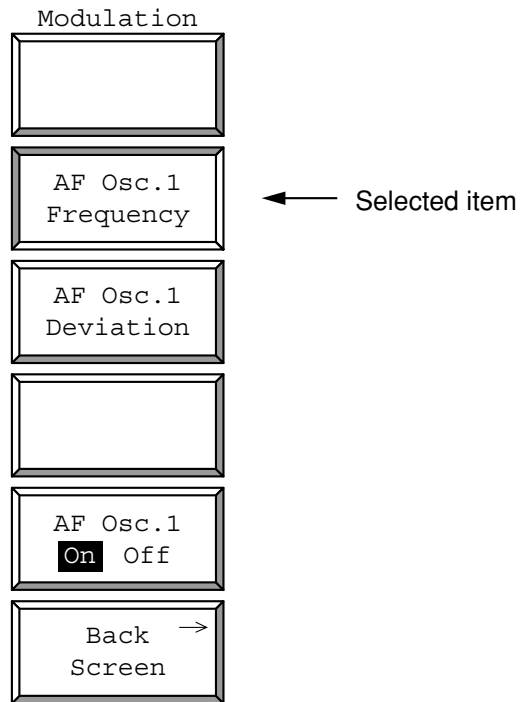

[Example of the main function key menu]

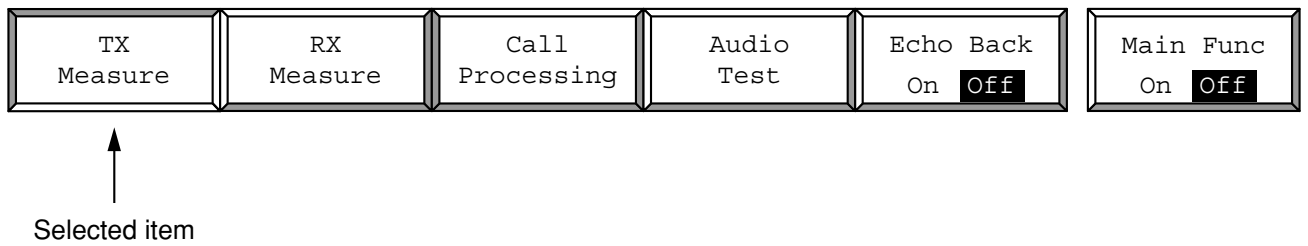

4.2.3 Entering data

(1) Entering numeric data by opening/closing the window

- (a) Entering numeric data by moving the cursor and opening/closing the window.

Move the cursor to the brackets enclosing the item to be set, then press the Set key. The value setting window shown below is opened and numeric data can be set.

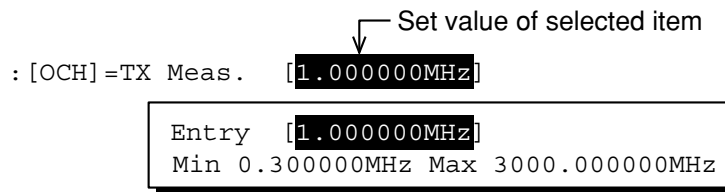

When a value is entered using the ten-keypad, Step key, or encoder, then press the unit or Set key, the numeric data is defined and the window is closed.

If the Cancel key, a function key or main function key is pressed while the window is open, the window is closed and the previously set value is displayed.

- (b) Entering numeric data by pressing a function key or main function key.

When the key marked # on the top right of the menu is pressed, the value setting window shown below is opened and numeric data can be set.

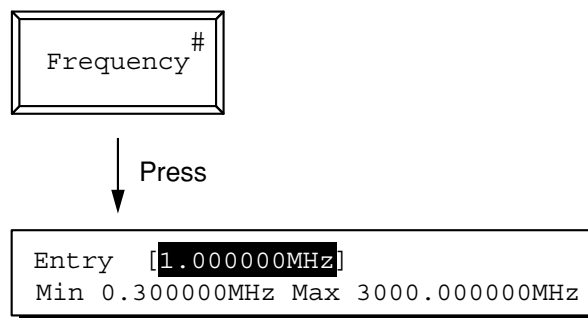

When a value is entered using the ten-key pad, Step key, or encoder, then press the unit or Set key, the numeric data is defined and the window is closed.

If the Cancel key, a function key or main function key is pressed while the window is open, the window is closed and the previously set value is displayed.

(2) Entering selection item by opening/closing the window

Move the cursor to the brackets enclosing the item to be set, then press the Set key. The selected item setting window shown below is opened and the selected item can be set.

RF Input : [Main]



When an item in the window is selected using the cursor keys and the Set key is pressed, the set value is defined and the window is closed.

(3) Entering selected items using alternate keys

Selection items are displayed on the function key menu. Each time one of these keys is pressed, set values are switched alternately. The currently selected item is reverse displayed.



RF Level
On Off

(4) Entering selected items using function keys with lower hierarchy

When the key marked * on the top right of the menu is pressed, the menu set of the lower hierarchy shown below is displayed.

Select an item from the menu set and press the corresponding function key. The menu display of the selected item is changed. When the return function key is pressed, display returns to the menu set of the higher hierarchy.

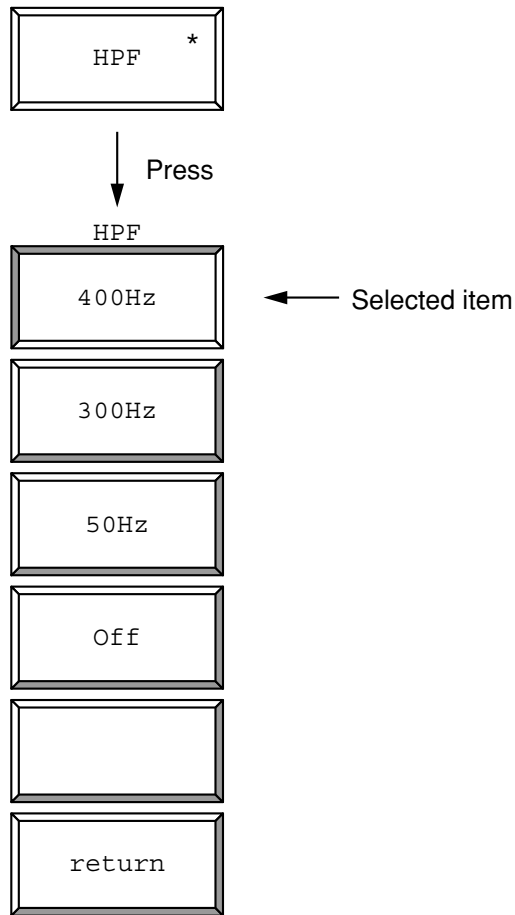

(5) Entering title

See paragraph 4.3.6, “Instrument Setup screen of Option 01: Analog Measurement.”

4.3 Preparation

In order to use the GSM Audio Test, the MT8801C and the radio under test should be in the communication state. In the following description, it is assumed that the MT8801C and the radio under test are in the communication state. Refer to “MX880115A Operation Manual, Section 4 Operation” for information on the communication state between the MT8801C and the radio under test.

4.3.1 Setup for transmission audio measurement (TX Audio)

AF signal from the MT8801C is audio-encoded, and the RF signal is modulated by the audio signal in the radio under test. The modulated RF signal is received, demodulated, and decoded by the MT8801C; and the frequency and level of the AF signal decoded are measured.

- AF signal for modulation is outputted from the MT8801C to the radio under test, using one of the following two methods.
 - (a) Using AF Output connector at front panel
Refer to the paragraph 4.3.1 of Option 01: Analog Measurement.
 - (b) Using DUT Interface connector at front panel
Refer to the paragraph 4.3.1 of Option 01: Analog Measurement.

4.3.2 Setup for reception audio measurement (RX Audio)

Modulated RF signal from the MT8801C is received, demodulated, and decoded by the radio under test. The audio signal is inputted to the MT8801C and the frequency and level of the main audio signal component are measured.

Modulated RF signal from the MT8801C is received, demodulated, and audio-decoded by the radio under test. The audio signal decoded is inputted to the MT8801C to measure the frequency and level of the fundamental component of the audio signal. Refer to the paragraph 4.3.2 of Option 01: Analog Measurement.

4.3.3 Setup for audio echo measurement (Audio Echo)

AF signal outputted from the MT8801C is encoded, and AF signal outputted from the MT8801C is encoded, and the RF signal is modulated by the audio-encoded signal in the radio under test.

The sent data in the RF signal of the radio is echoed back from the MT8801C to the radio, and the level and frequency of the demodulated/audio-decoded audio signal of the radio are measured by the MT8801C.

To perform this measurement, set up the instruments as shown below.

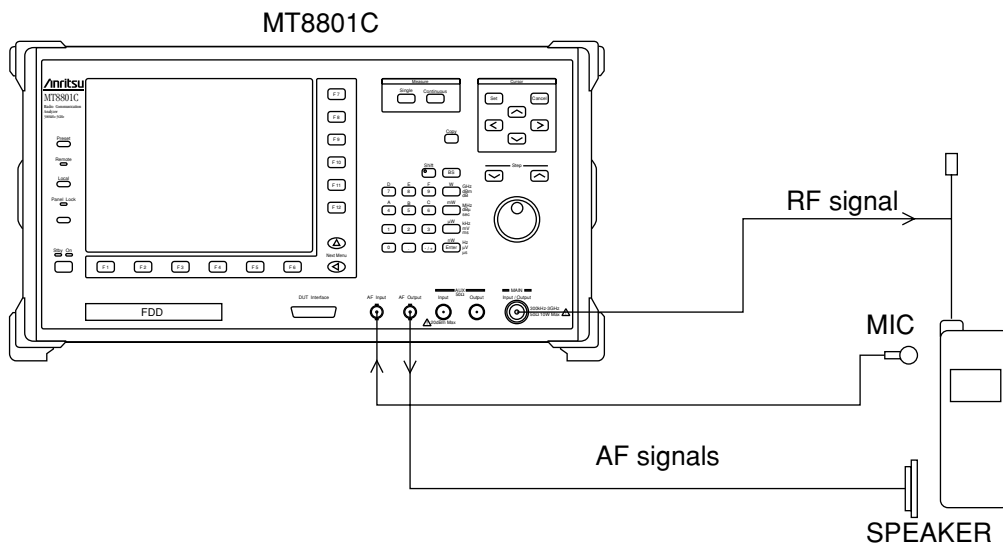

Fig. 4-2 Setup for Audio Echo Measurement

4.4 Setting Common Measurement Parameter — Setup Common Parameter screen

This paragraph describes newly added items and items whose setting range is changed for Options 10/11.

Note:

Refer to the MX880115A GSM Measurement Software operation manual for the items that are not described below.

- Set the common measurement conditions on this screen.
Move to the Setup Common Parameter screen by following the steps below.

Step	Key operation	Description
1.	[Main Func On Off] F6	Sets Main Func on. The Main-menu 1st page appears at the bottom of the screen.
2.	[Tx Rx Tester] F1	Enters the Tx Tester mode. The Setup Common Parameter screen appears.
3.	[Tx Measure] F1	Function keys are displayed at F7 to F12.

Section 4 Operation

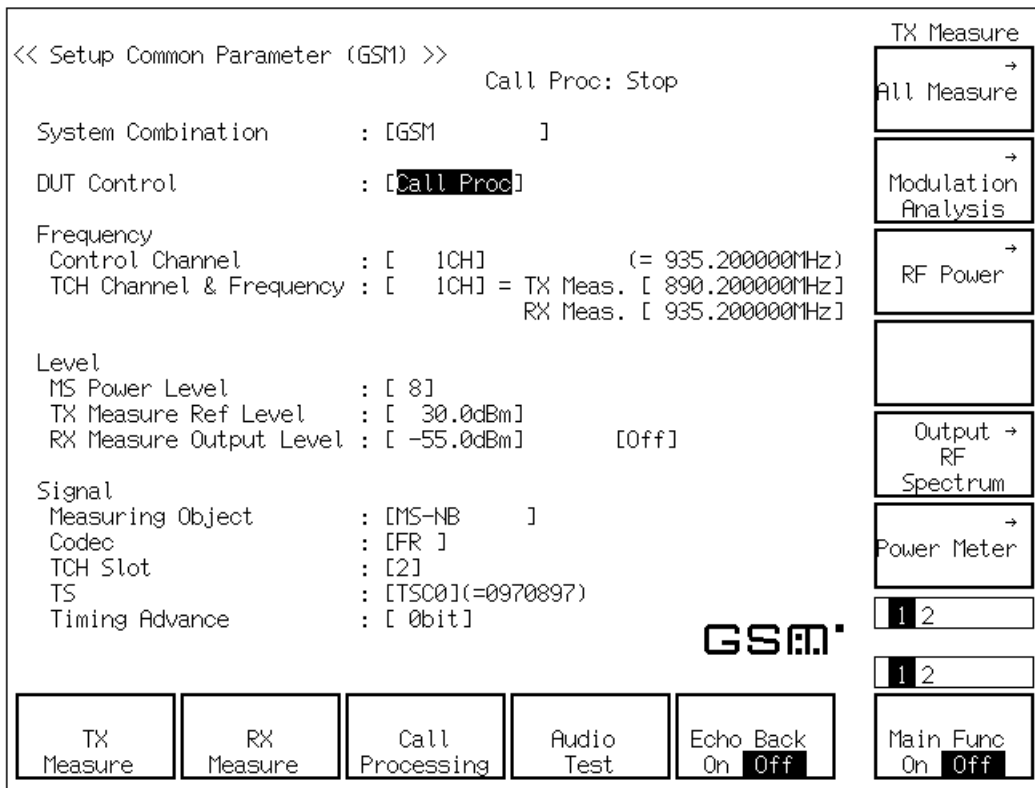

Fig. 4-3 Setup Common Parameter screen

Installing the Options 10/11, the [Audio Test]F4 and [Echo Back]F5 Main-function keys are displayed when the [Call Proc] is selected at DUT Control item on the screen.

[Audio Test] F4

Displays the GSM Audio Test function keys on F7 to F9.

[Echo Back] F5

Selects On/Off of the Echo Back to the radio under test that is in the communication state (Call Proc: Communication) with the MT8801C.

Selection of Echo Back

When Loop Back is Off:

By pressing the [Echo Back]F5 key, On/Off of echo back can be selected.

When Loop Back is On:

The display of [Echo Back]F5 key disappears, and Echo Back cannot be selected. When Loop Back is set to Off, the Echo Back state returns to the previous one.

When one of the GSM audio measurement screens (TX Audio, RX Audio, or Audio Echo screen) is displayed:

The measurement is automatically performed by setting both the Echo Back and Loop Back to off in MT8801C.

Note:

The query to Echo Back or Loop Back during remote operation, return the previous state immediately before entering the measurement screen.

[Echo Back]:

A function in which the MT8801C loops back the communication channel information of the radio under test in the communication state with the MT8801C.

[Loop Back]:

A function in which the radio under test in the communication state with the MT8801C loops back the communication channel information sent by the MT8801C.

4.5 Transmission Audio Measurement — TX Audio screen

The level and frequency of the audio data in the RF signal outputted from the radio under test in the communication state with the MT8801C, are measured.

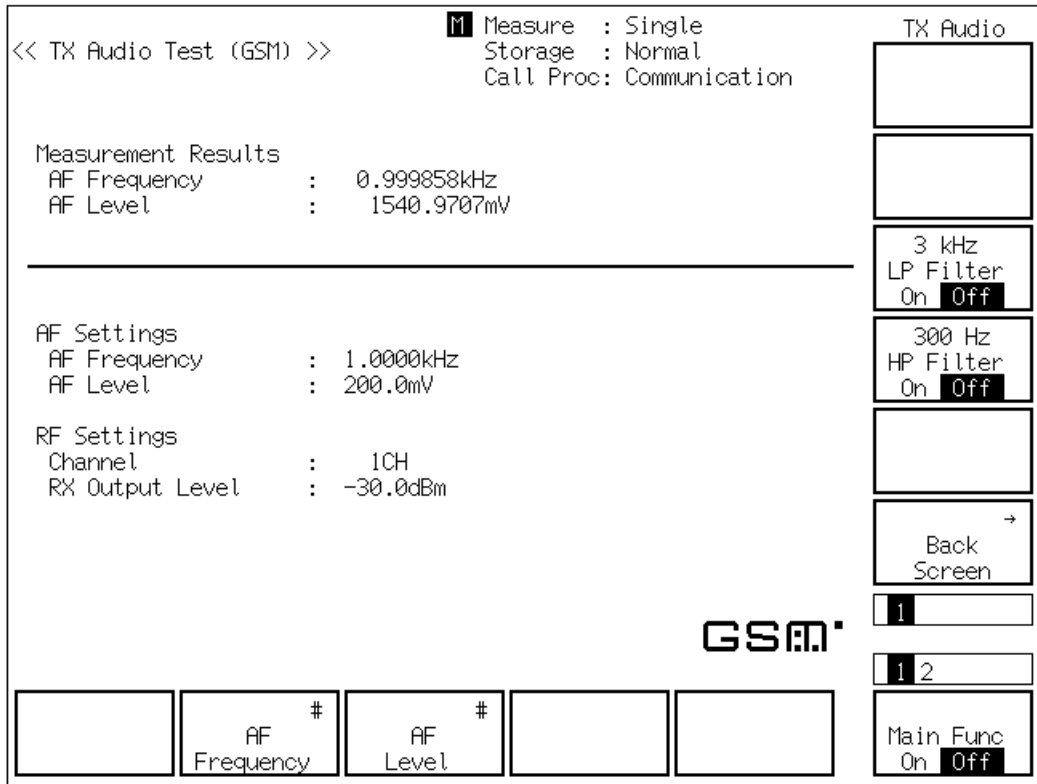

Fig. 4-4 TX Audio Screen

[Measurement Results]

- AF Frequency [kHz] Displays the frequency of the fundamental component of the audio data in the RF signal received by the MT8801C.
- AF level [mV] Displays the level of the audio data in the RF signal received by the MT8801C.

[AF Settings]

- AF Frequency Displays the frequency of the AF signal outputted from the MT8801C.
- AF Level Displays the level of the AF signal outputted from the MT8801C.

[RF Settings]

- Channel Displays the channel in communication with the radio under test.
- RX Output Level Displays the level of the RF signal outputted from the RF Output connector of the MT8801C.

Frame noise measurement function:

A 217 Hz signal of frame noise can be measured by setting the AF frequency to 217 Hz. When the AF frequency is set to 217 Hz, the signal from the Audio Out connector of the radio under test is turned OFF automatically.

- [AF Frequency] F2 Sets the frequency of the AF signal outputted from the MT8801C. (Initial value: 1 kHz)
- [AF Level] F3 Sets the level of the AF signal outputted from the MT8801C. (Initial value: 100 mV)

4.5.1 Timing of transmission audio measurement

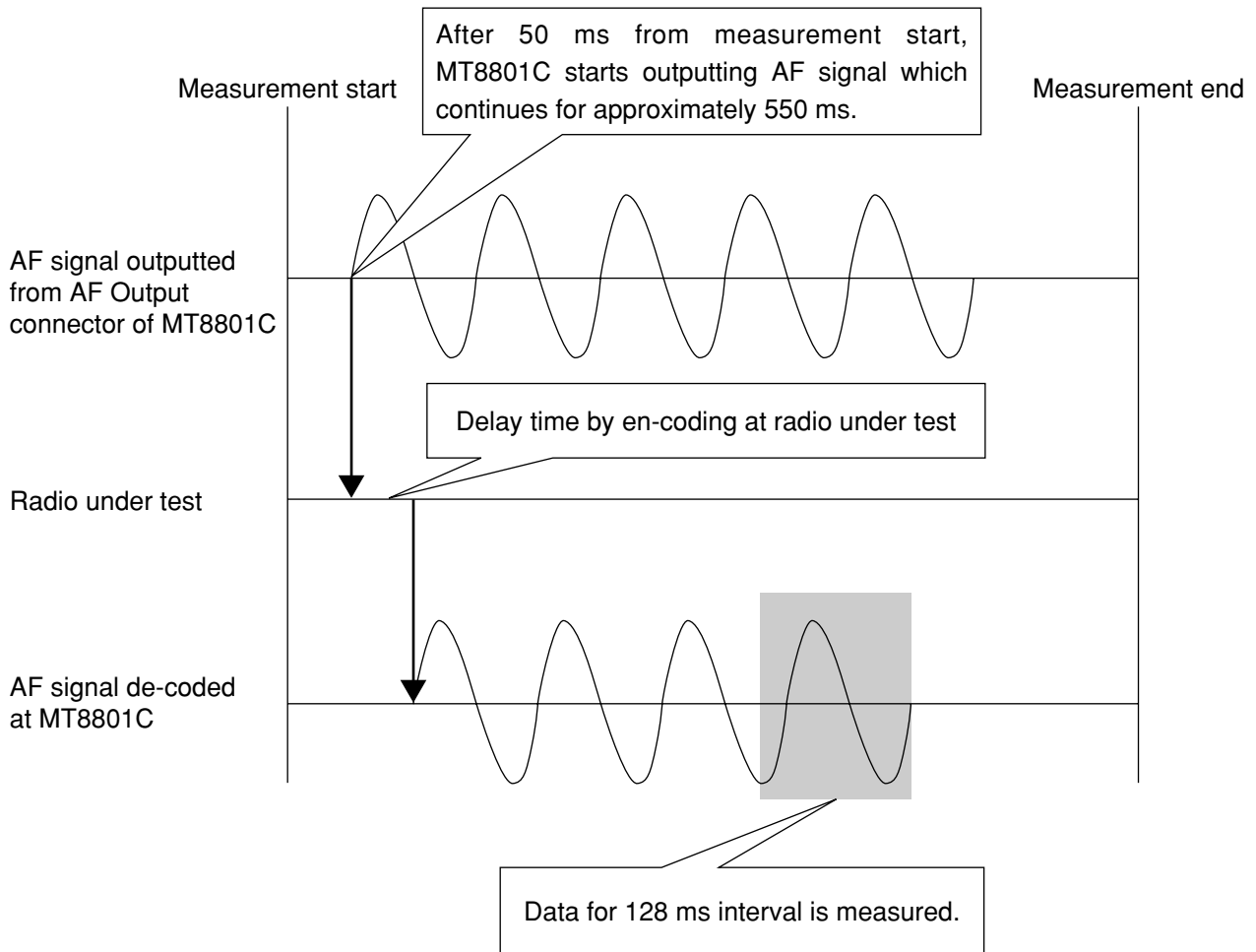
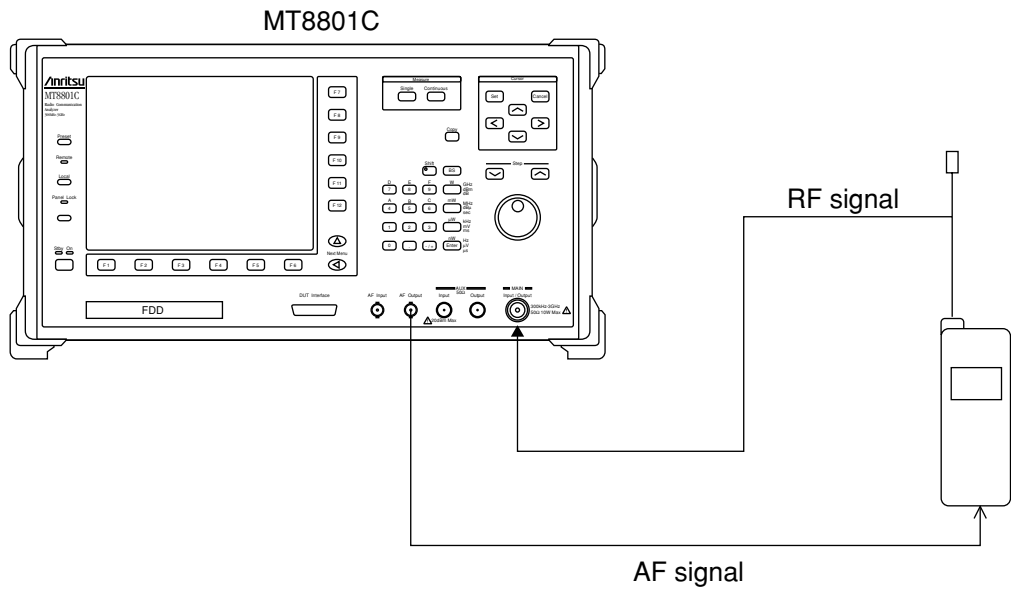

4.6 Reception Audio Measurement — RX Audio screen

The level and frequency of the audio signal outputted from the radio under test which receives the RF signal with audio data outputted from the MT8801C in the communication state with radio, are measured.

The level and frequency of the audio signal from the radio are measured.

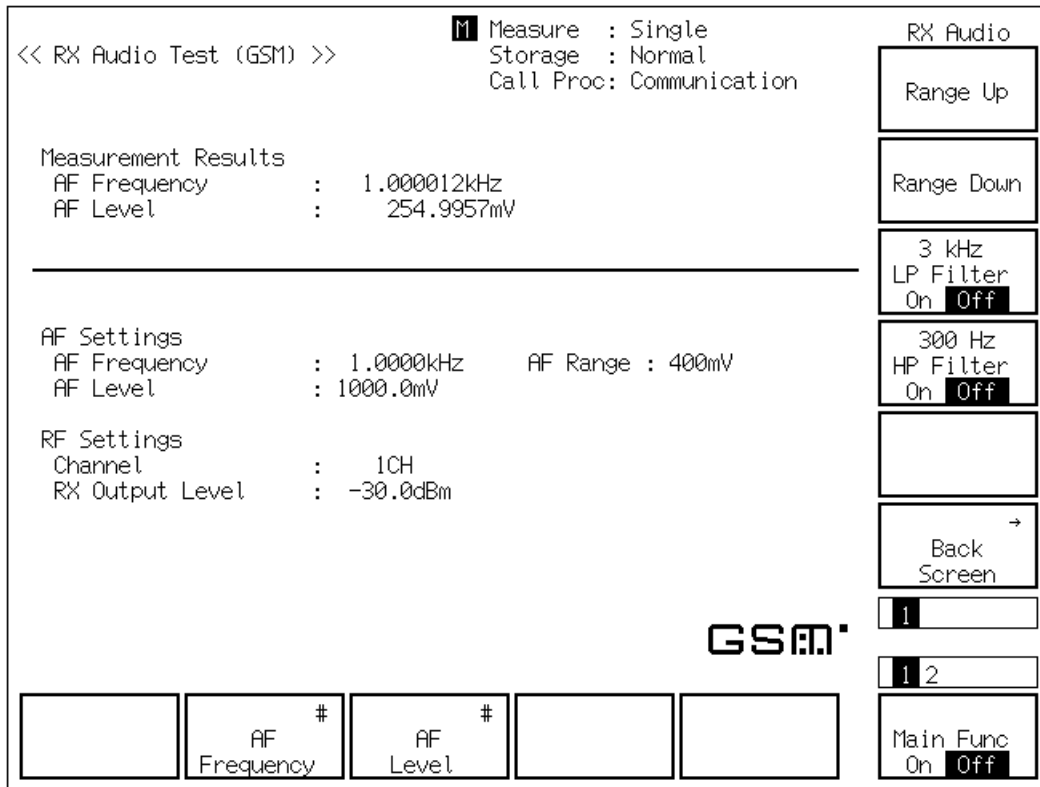

Fig. 4-5 Rx Audio Screen

[Measurement Results]

AF Frequency [kHz]	Displays the frequency of the fundamental component of the audio signal received by the MT8801C.
AF level [mV]	Displays the level of the audio signal received by the MT8801C.

[AF Settings]

AF Frequency	Displays the frequency of the audio signal for audio-encoding by the MT8801C.
AF Level	Displays the level of the audio signal for audio-encoding by the MT8801C.

[RF Setting]

Channel	Displays the channel in communication with the radio under test.
RX Output Level	Displays the level of the RF signal outputted by the MT8801C from the RF Output connector.

Frame noise measurement function:

A 217 Hz signal of frame noise can be measured by setting the AF frequency to 217 Hz. When the AF frequency is set to 217 Hz, the Vocoder in the MT8801C audio-encodes the no-audio data for the RF modulation, and the MT8801C transmits the RF modulated signal to the radio under test.

[AF Frequency] F2 The frequency of the audio signal for audio-encoding by the MT8801C, can be set. (Initial value: 1 kHz)

[AF Level] F3 The level of the audio signal for audio-encoding by the MT8801C, can be set. (Initial value: 100 mV)

4.6.1 Timing of reception audio measurement

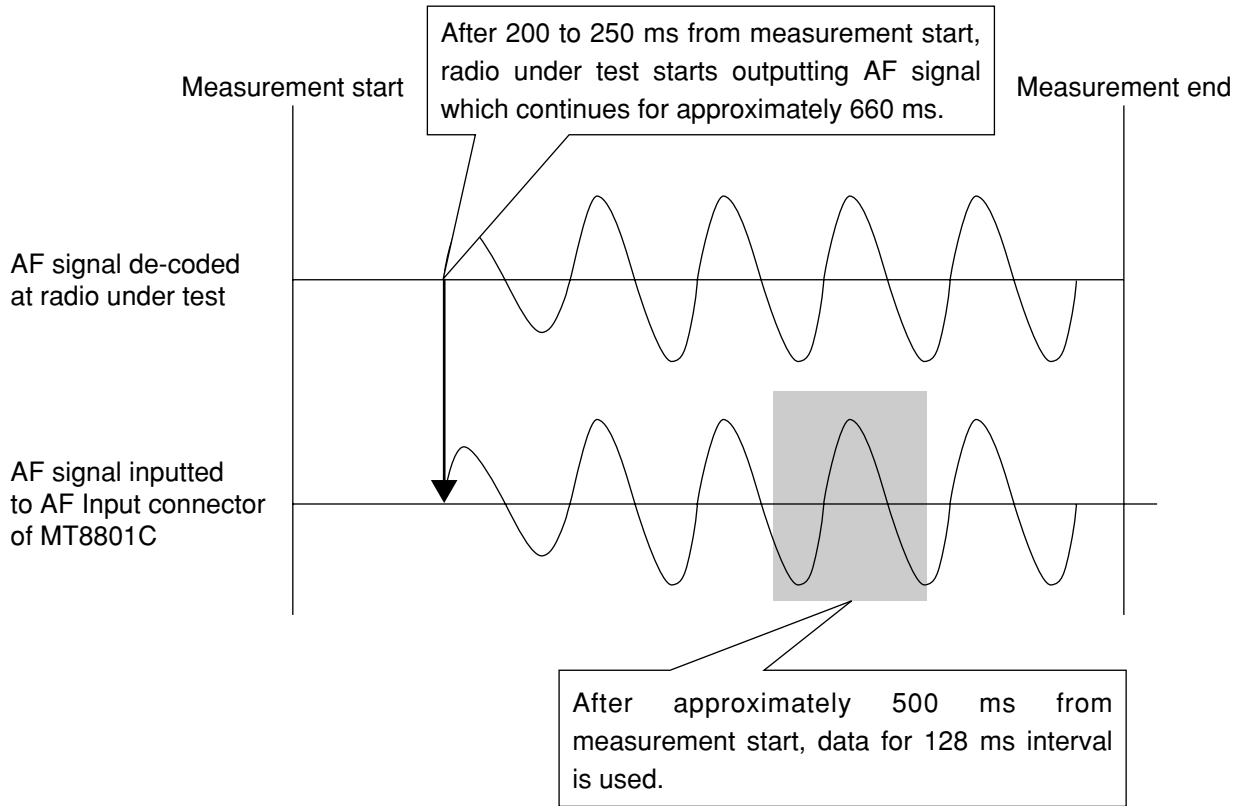
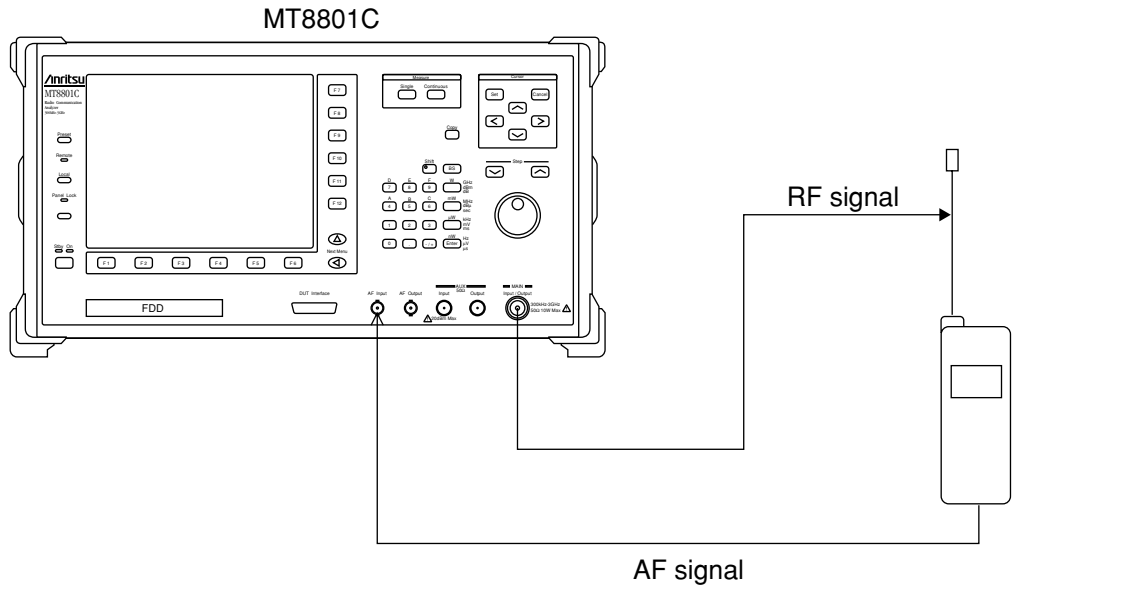

4.7 Audio Echo Measurement — Audio Echo screen

AF signal outputted from the MT8801C is encoded, and the RF signal is modulated by the audio-encoded signal in the radio under test.

The sent data in the RF signal of the radio is echoed back from the MT8801C to the radio, and the level and frequency of the demodulated/audio-decoded audio signal of the radio are measured by the MT8801C.

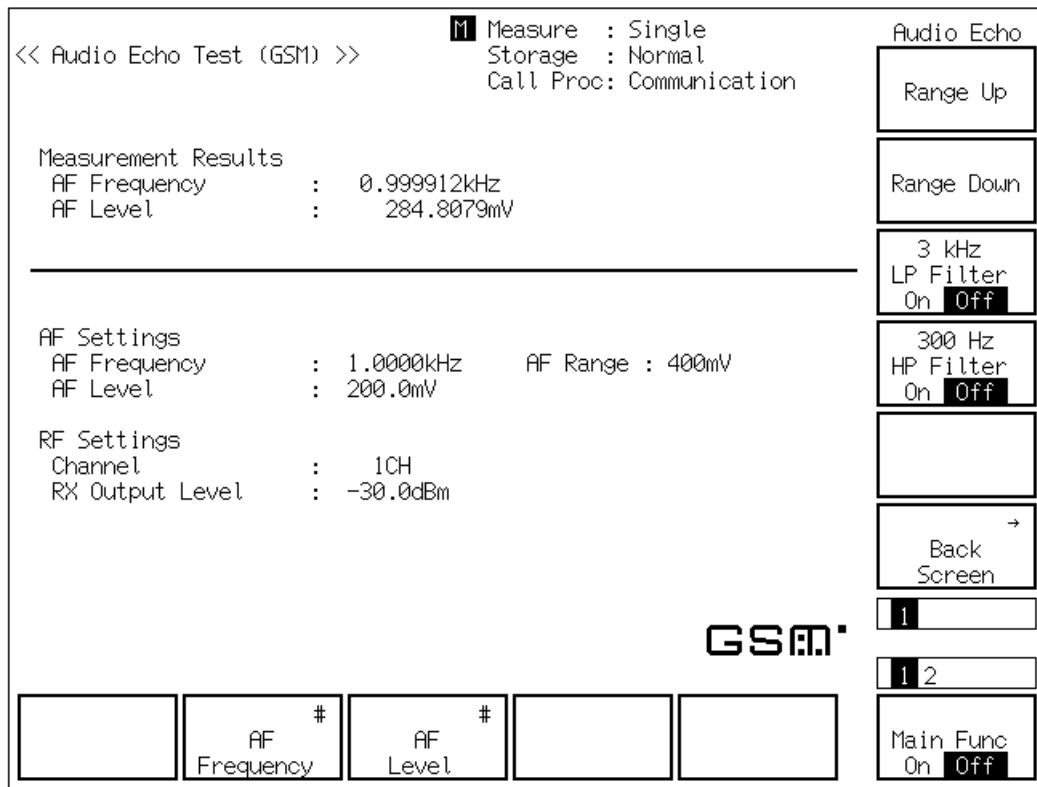

Fig. 4-6 Audio Echo Screen

[Measurement Results]

AF Frequency [kHz] Displays the frequency of the fundamental component of the audio signal to AF Input connector from the radio under test.

AF level [mV] Displays the level of the audio signal to AF Input connector from the radio under test.

[AF Settings]

AF Frequency Displays the frequency of the AF signal for encoding in the radio under test.

AF Level Displays the level of the AF signal for encoding in the radio under test.

[RF Settings]

Channel Displays the channel in communication with the radio under test.

RX Output Level Displays the RF signal level outputted from the MT8801C.

[AF Frequency] F2 Set the frequency of the AF signal outputted from the MT8801C. (Initial value: 1 kHz)

[AF Level] F3 Set the level of the AF signal outputted from the MT8801C. (Initial value: 100 mV)

4.7.1 Timing of audio echo measurement

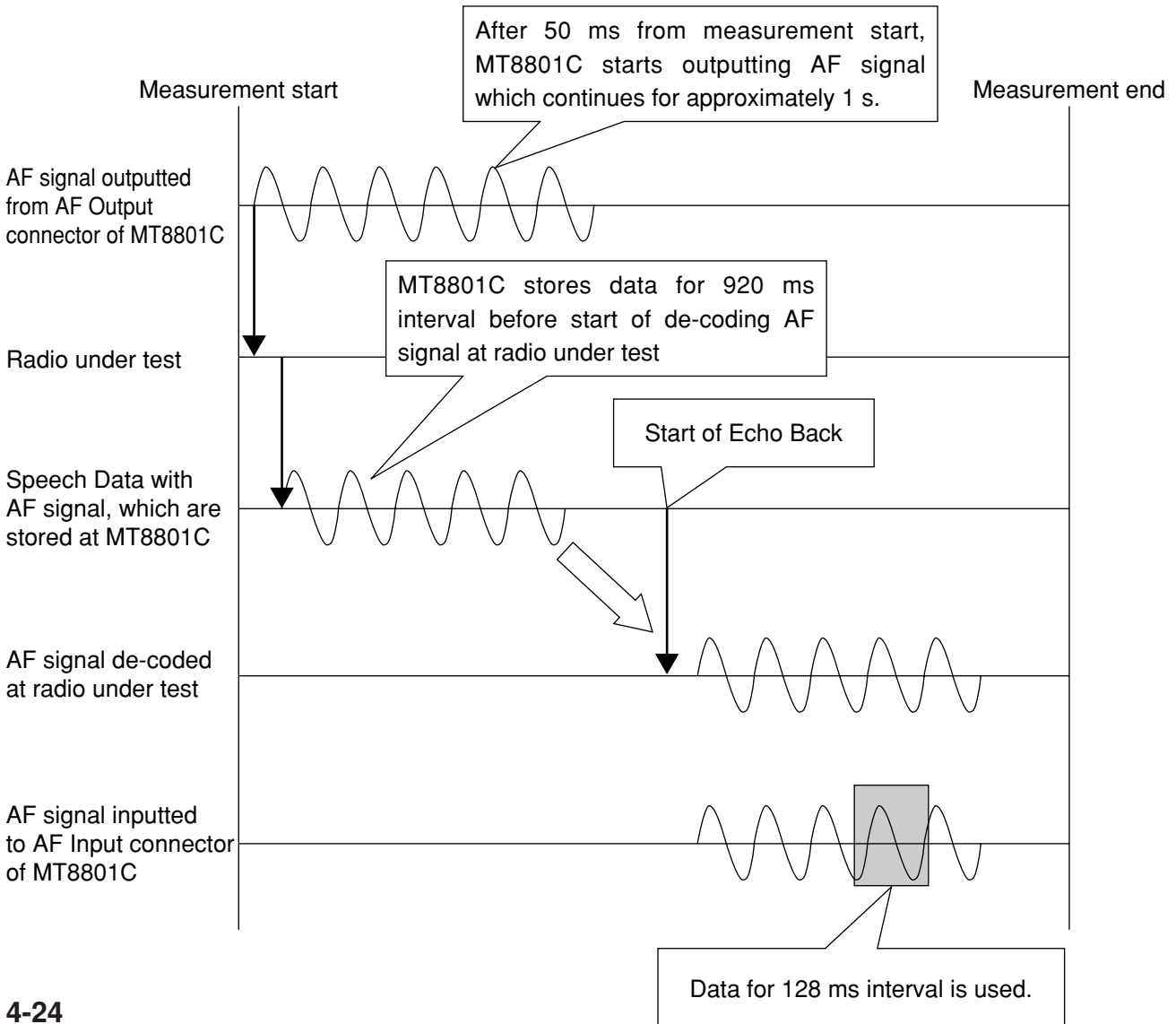
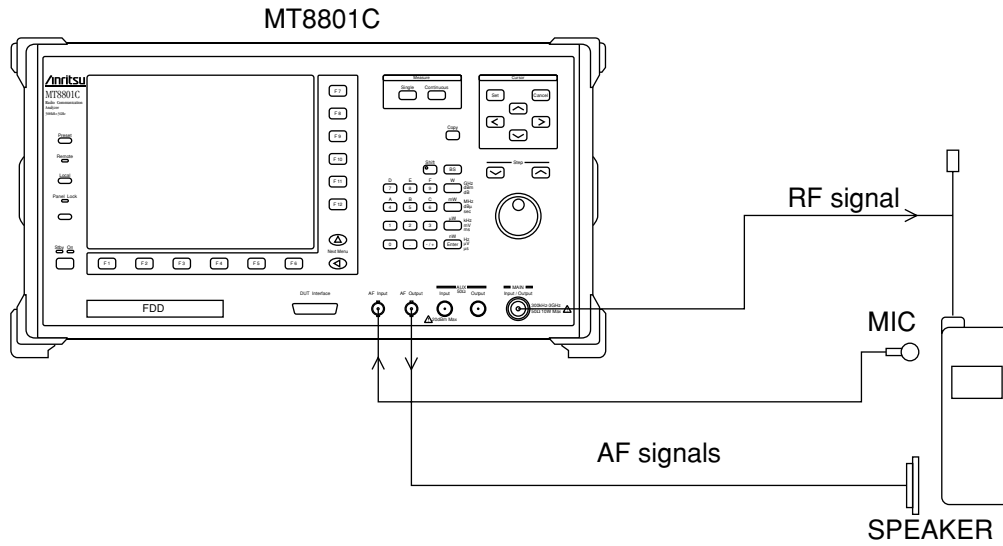

4.8 Saving and recalling parameter data — Save Parameter screen, Recall Parameter screen

Display the Save Parameter and Recall Parameter screens according to the following steps to save or recall parameters set for the Analog Measurement.

Step	key operation	Description
1.	[Main Func on off]F6	Sets the Main Func on. The first page of the Main Menu appears at the bottom of the screen.
2.	[Recall]F4	Sets Recall Parameter mode. The Recall Parameter screen appears. The Recall function key menu appears on F7 to F12.
2'	[Save]F5	Sets Save Parameter mode. The Save Parameter screen appears. The Save function key menu appears on F7 to F12.

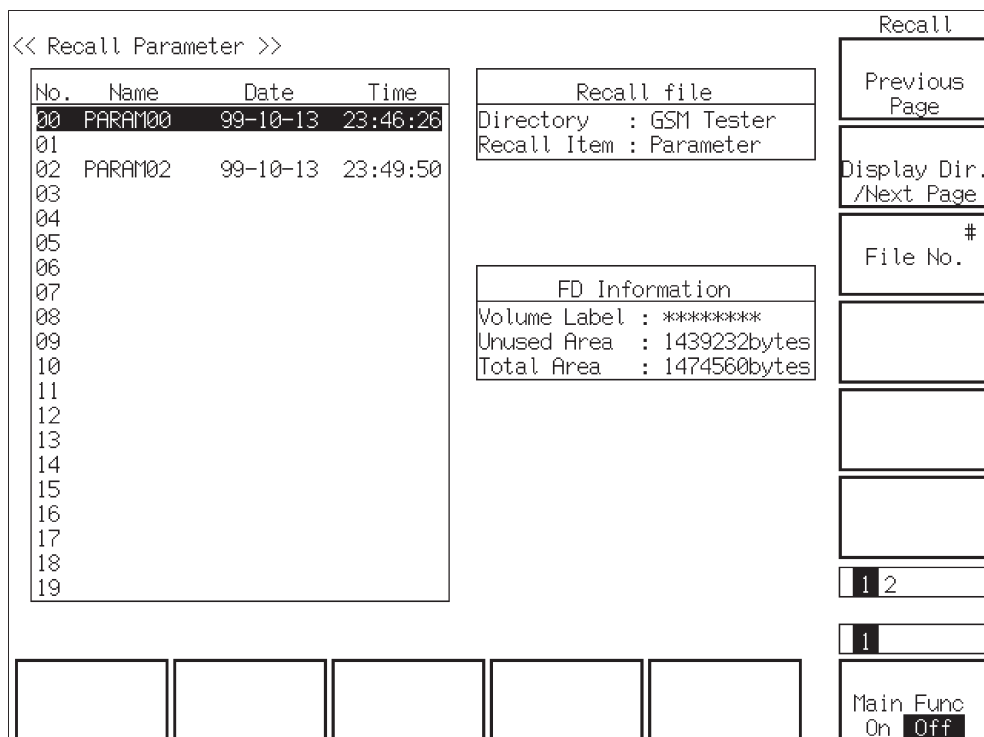

Fig. 4-7 Recall Parameter Screen

Section 4 Operation

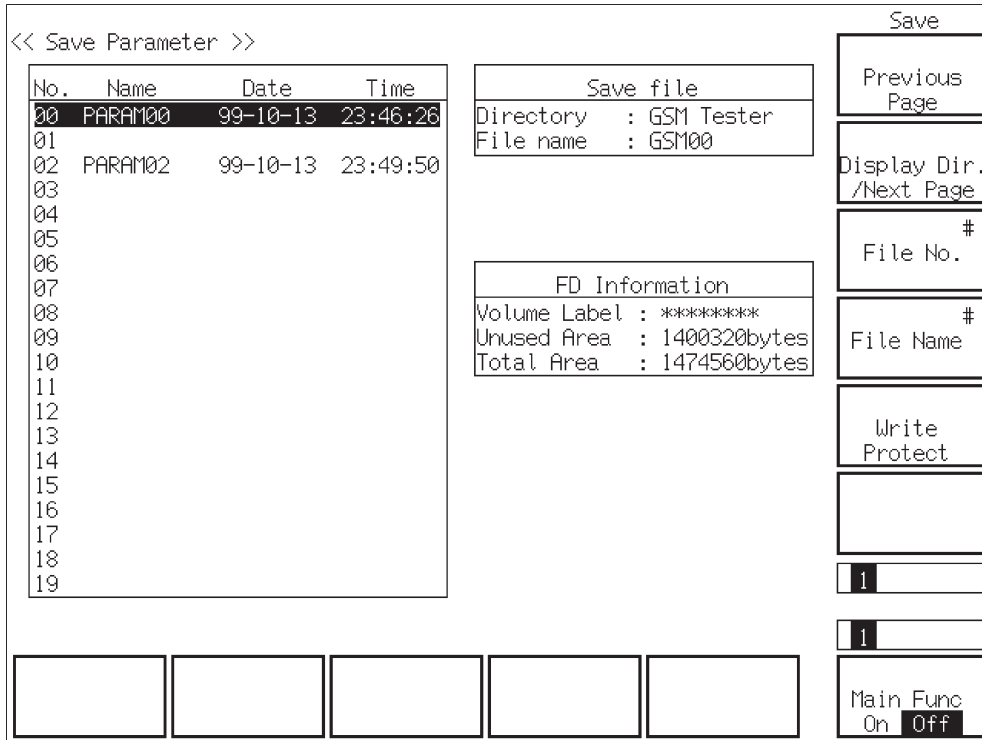

Fig. 4-8 Save Parameter Screen

• Floppy disk to be used:

For saving and loading parameters and data, use the floppy disk described in Section 3. When the floppy disk is required to be formatted, use the File Operation screen in Paragraph 4.9.

• Notes when displaying the Save Parameter screen and Recall Parameter screen:

Before pressing the [Save]F5 or [Recall]F4 function key, insert a floppy disk(FD) in the FD driver of the MT8801C. Then press the key. The MT8801C automatically starts the FD-driver operation.

• Screen display and function key display:

Pressing the [Save]F5 or [Recall]F4 function key changes only the display of the F7 to F12 function keys.

The screens (Figs. 4-7, 4-8) appear when the [Display Dir./Next Page] F8 key is pressed to display the contents of the FD. These screens also display the function keys used to select any directory and any file.

• Information to be saved and recalled:

The [Save] and [Recall] keys on the main function keys saves and recalls all the measurement parameters.

4.8 Saving and recalling parameter data — Save Parameter screen, Recall Parameter screen

• Function keys on the Recall Parameter screen

Main function key: None

Recall function keys:

[Display Dir.]F8: Accesses the floppy disk and displays the directory of the parameter data file.
The lower-order Recall menu appears.

** 1st page**

[Previous Page]F7: Displays the previous page of the directory.

[Display Dir./Next Page]F8: Accesses the floppy disk and displays the next page of the directory.

[File No.]F9: Opens the window for entering the recall position (number) of the setup parameter data file.

0 to 99, Resolution: 1, Initial value: 0

** 2nd page **

[Select Display Mode]F7: Displays the Display Mode menu to select a display mode.

[Wide]F7: Displays file numbers in ascending order from 0 regardless of whether all files are saved.

[Narrow]F8: Skips the numbers of files not saved and displays only the numbers of saved files in ascending order.

[return]F12: Returns to the previous menu.

[File No.]F9: Opens the window for entering the recall position (number) of the setup parameter file.

0 to 99, Resolution: 1, Initial value: 0

[return]F12: Returns to the previous menu.

• Function keys on the Save Parameter screen

Main function key: None

Save function keys:

[Display Dir.]F8: Accesses the floppy disk and displays the directory of the parameter data file.
The low-order Save menu appears.

[Previous Page]F7: Displays the previous page of the directory.

[Display Dir./Next Page]F8: Accesses the floppy disk and displays the next page of the directory.

[File No.]F9: Opens the window for entering the save position (number) of the setup parameter data file.

0 to 99, Resolution: 1, Initial value: 0

[File Name]F10: Opens the window for entering the name of the parameter data file to be saved.

The data file name consists of up to eight characters.

Section 4 Operation

[Write Protect]F11: Write-protects the specified parameter data file.
 An asterisk (*) is displayed at the end of the name of the write-protected file.
 If the specified parameter data file is already write-protected, this key cancels write protect.
 Note: This function can only be executed through panel operation.

[File No.]F9: Opens the window for entering the save position (number) of the setup parameter data file.
 0 to 99, Resolution: 1, Initial value: 0

[return]F12: Returns to the previous menu.

• Saving parameters and data

This paragraph describes how to save the measurement parameters of the Analog Measurement to a floppy disk.

Step	key operation	Description
1.		Insert a saving floppy disk (FD) into the FD driver on the bottom left of the MT8801C.
2.	[Main Func on off]F6	Sets Main Func to on. The Main Menu 1st page is displayed on the screen bottom.
3.	[Save] F5	Changes to Save Parameter mode. Displays the Save function keys in F7 to F12, and then moves to the Save screen for parameter and data. Searches the FD for parameter and data files, and displays them on the screen.
4.	[Display Dir./Next Page]F8	Displays existing files to check the number of the file to be saved.
5.	[File Name]F10	Sets the file name used for save within 8 alphanumeric characters if necessary.
6.		Check the number of the file to be saved and the file status (whether the file exists and whether the file is write-enabled). To write-enable the file, proceed to Steps 7a and later. Otherwise, proceed to Step 8.
7a.	Cursor [^] and [v]	Select the file to be write-enabled.
7b.	[Write Protect] F11	Write-enables the file for over-writing.
8.	[File No.] F9	Specify the number of the file to be saved.
9.	[Set]	Saves the file.
10.	SAVE? Yes No	Opens SAVE confirmation window. Select YES.

4.8 Saving and recalling parameter data — Save Parameter screen, Recall Parameter screen

• Write-protecting or write-enabling the file to be saved

This paragraph describes how to write-protect or write-enable the file containing data in the Save screen.

Step	key operation	Description
1.		Execute the Steps 1 to 3 of the saving procedure in the previous paragraph to display the Save menu.
2.	[Display Dir./Next Page]F8	Displays the existing files. Check the number of the file to be saved.
3.	Cursor [^], [v]	Select the file to be write-enabled.
4.	[Write Protect]F11	Write-protects or write-enables the file to be saved.

• Recalling parameters and data

This paragraph describes how to recall Analog measurement parameters from the floppy disk.

Step	key operation	Description
1.		Insert a recall floppy disk (FD) into the FD driver at the bottom left of the MT8801C.
2.	[Main Func on off]F6	Sets Main Func to on. Displays Main Menu 1st page on the screen bottom.
3.	[Recall]F5	Changes to Recall Parameter mode. Displays the Recall function keys in F7 to F12, and moves to the Recall screen for parameter and data. Searches the FD for parameter and data files, and displays them on the screen.
4.	[Display Dir./Next Page]F8	Displays the directory containing the file to be recalled. Check the file to be recalled.
5.	Cursor[^][v]	Select the file to be recalled.
6.	[File No.]F9 (The file to be recalled can be specified by the file number, too.)	Sets the number of any file to be recalled.
7.	[Set]	Confirms the file to be recalled.
8.	RECALL? Yes No	Opens RECALL confirmation window. Select YES. The MT8801C reads the specified file. Then, returns to the previous screen, automatically.

• Changing the recall-file display format (WIDE/NARROW)

This paragraph describes how to change the recall-file display format (WIDE/NARROW).

Step	key operation	Description
1.		Execute the Steps 1 to 3 of the recalling procedure in the previous paragraph to display the recalled file.
2.	Next Menu [^]	Displays the second page of the function keys.
3.	[Select Display Mode]F7	Displays the file display format selection menu.
4.	[Wide]F7 or [Narrow]F8	Specify the display format.
5.	[return]F12	Returns to the previous menu.

4.9 Operating the file — File Operation screen

To access the floppy disk and display the parameter file directory, delete or write-protect the parameter file, and initialize the floppy disk; display the File Operation screen according to the following steps.

Note:

This function can only be executed through panel operation.

Step	key operation	Description
1.	[Main Func on off]F6	Sets the Main Func on. The Main Menu 1st page appears at the bottom of the screen
	Next Menu [◀]	Displays the second page of the Main Menu.
2.	[File Operation]F4	Sets File Operation mode. The File Operation screen appears. The File function key menu appears on F7 to F12.

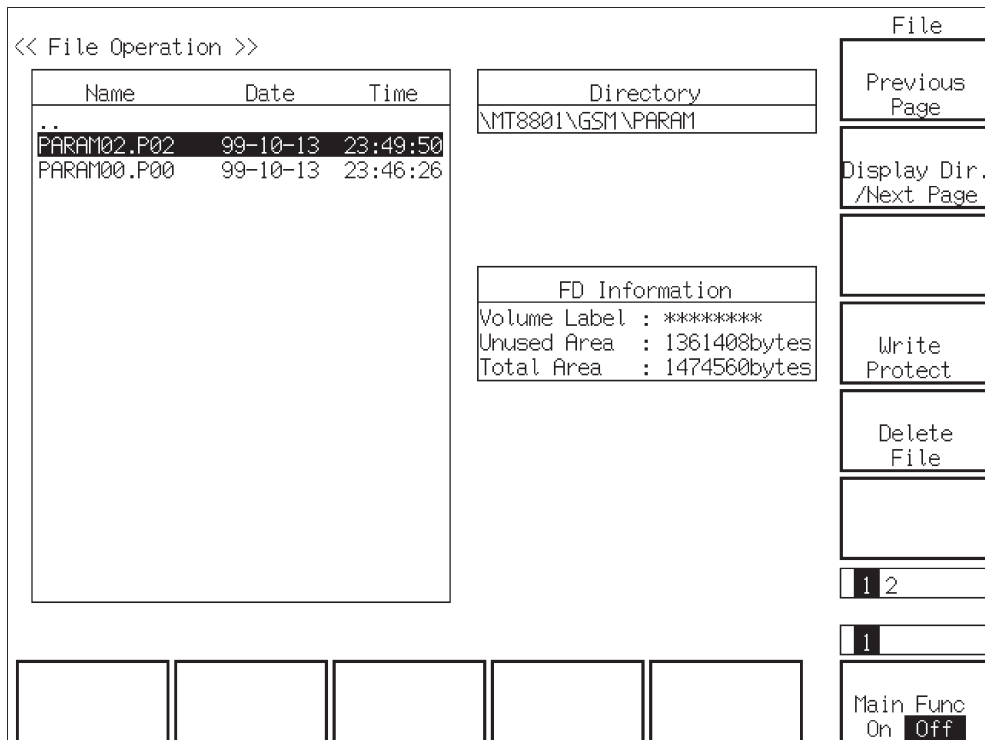

Fig. 4-9 File Operation Screen

• Functions keys on the File Operation screen

Main function key: None

Function keys: 2 pages. Use the Next Menu [▲] key to scroll to the next page.

** 1st page **

[Previous Page]F7: Displays the previous page of the directory.

[Display Dir./Next Page]F8: Accesses the floppy disk and displays the next page of the directory.

[Write Protect]F10: Write-protects the specified parameter data file.

An asterisk (*) is displayed at the end of the name of the write-protected file.

If the specified parameter data file is already protected, write protect can be canceled by pressing this key.

Note:

This function can only be executed through panel operation.

[Delete File]F11:

Opens the window for entering the position (number) of the parameter data file to be deleted.

Setup range: 0 to 99 (integer)

Initial value: 0

** 2nd page **

[Format]F7: Initializes the floppy disk to the specified type. The initialization format is MS-DOS 1.44 MB or 720 kB.

Note:

The format is MS-DOS 1.44 MB or 720 kB.

Use the 2HD or 2DD type of 3.5-inch floppy disk.

Section 4 Operation

• Displaying files

This paragraph describes how to display the files in FD.

Step	key operation	Description
1.		Insert a floppy disk (FD) into the FD driver at the bottom left of the MT8801C.
2.	[Main Func on off]F6	Turn the Main Func on to display the first page of the Main Menu at the bottom of the screen.
3.	Next Menu [◀]	Displays the second page of the Main Menu.
4.	[File Operation]F4	Moves to the File Operation screen. Accesses the FD to display the root directory.
5.	Cursor [^] [v]	Specify the directory to be required.
6.	[Set] or [Enter]	Moves to the specified directory to display its contents.
7.		Repeat the Steps 5 and 6 above to display the required directory.

Note:

The sub-directories and file name under the selected directory are displayed in the frame on the left of the screen.

For directories, only their names are displayed in the “Name” field.

For files, Name/Date/Time are displayed.

The Directory field at the upper right of the screen displays the layer and location of the selected directory.

• Write-enabling/write-protecting files

This paragraph describes how to change the file write mode between the write-protected and write-enabled modes.

Step	key operation	Description
1.		Select the directory of the desired file by the displaying-file procedure above.
2.	Cursor [^] [v]	Specify the file.
3.	[Write Protect]F10	Changes the file write mode.

• Deleting files

This paragraph describes how to delete the parameter/data files.

Step	key operation	Description
1.		Select the directory of the desired file by the displaying-file procedure above.
2.	Cursor [^] [v]	Specify the file.
3.	[Delete File]F11	Opens the confirmation window.
4.	DELETE FILE? Yes No	Select Yes or No. “Yes” deletes the specified file.

Note:

Once a file is deleted, it cannot be restored.

• Initializing (formatting) floppy disk

This paragraph describes how to initialize a floppy disk.

Step	key operation	Description
1.		Insert a floppy disk (FD) into the FD driver at the lower left of the MT8801C. The acceptable FD is the 2HD (1.44 M-bytes) or 2DD (720 k-bytes) type.
2.		Set File Operation mode, as described previously.
3.	Next Menu [^]	Displays the second page of the function keys.
4.	[Format]F7	Specifies initialization.
5.	FORMAT DISK? Yes No	The window confirming FORMAT DISK appears on the screen. Select Yes.
6.	Next Menu [^]	Returns to the first page of the function keys.

Note:

Once a floppy disk is initialized, the data recorded on the disk is all lost.

4.10 Screen hard copy — Copy

The copy function transfers a screen display to the printer or floppy disk. Specify a transfer destination and mode on the Instrument Setup screen. Press the Copy key on the front panel to activate the Copy function. While the Copy function is operating, operations (including remote control) such as measurement or internal setting are disabled.

(1) Transfer to the printer

If Hard Copy is set to the Output Device Printer (Parallel) on the Instrument Setup screen, screen display can be printed via the Parallel interface on the rear panel. Printers using the ESC/P command system can be used.

(2) Transfer to the floppy disk

If Hard Copy is set to File on the Instrument Setup screen, the floppy disk driver on the front panel can be used to store data displayed on the screen in the floppy disk. Paragraph 4.9 describes the floppy disks that can be used. Data created on the floppy disk is the image file of the monochrome BMP data format. While the Copy is being executed, the name of the created file “RCA_***.BMP” is displayed on the bottom of the screen (*** is a number beginning with 000).

(Reference)	Number of storable BMP files
	2DD (720 K bytes): Up to 18
	2HD (1.44 M bytes): Up to 37

4.11 Settings relating to remote control and panel key control

1. Remote control interfaces

The remote control interfaces of the MT8801C are classified into the GPIB interface and serial interface (RS-232C interface). Select an interface used on the Instrument Setup screen (see paragraph 4.3.6 of Option 01: Analog Measurement.).

2. Remote control and panel control keys

The keys and lamps described in this section are assigned on the front panel as exclusive keys and lamps.

(1) REMOTE lamp and LOCAL key

The REMOTE lamp indicates that the MT8801C is controlled remotely using the GPIB interface or RS-232C interface. When the MT8801C is controlled remotely from an external controller via the GPIB interface or RS-232C interface, the REMOTE lamp lights. While the REMOTE lamp is on, key entry and rotary encoder entry from the front panel are disabled. The LOCAL key is used to cancel the remote control status of the GPIB interface or RS-232C interface. When the LOCAL key is pressed, the REMOTE lamp goes off and key entry and rotary encoder entry from the front panel are enabled.

(2) PANEL LOCK key

The PANEL LOCK key is used to enable and disable key entry and rotary encoder entry from the front panel. Use the PANEL LOCK key to prevent an incorrect operation on the front panel for automatic measurement or status holding. When the panel is locked, the green lamp on the PANEL LOCK key lights.

3. Remote control status

If the MT8801C is controlled remotely, the REMOTE lamp on the left of the front panel lights. While the REMOTE lamp is on, key entry and rotary encoder entry from the front panel are disabled. To change from the remote control status to the front panel entry status, execute the following steps:

- 1) Halt the remote control.
- 2) If the REMOTE lamp is on, press the LOCAL key to cancel the REMOTE status.

Section 5 Performance Tests

This section lists the equipment used in performing the MT8801C performance tests, and explains the setup and the performance test items of Options 10/11: Audio Test.

5.1	Requirement for Performance Tests	5-2
5.2	Instruments Required for Performance Test	5-2
5.3	Performance Tests	5-3
5.3.1	AF oscillator	5-3
5.3.2	Audio analyzer	5-5
5.3.3	Example of performance test result entry sheet.....	5-6

5.1 Requirement for Performance Tests

The performance tests are carried out as a part of preventive maintenance to prevent deterioration of option 10/11: Audio Test of the MT8801C.

Use the performance test procedures during acceptance inspection, periodic inspection, and after repair of of Options 10/11: Audio Test of the MT8801C. Do the important parts of preventive maintenance periodically. This section explains the following test procedures:

- AF oscillator
Output level accuracy and waveform distortion
- Audio analyzer
AF level measurement accuracy

For important evaluation items, execute the performance tests at regular intervals for preventive maintenance. The performance should be inspected regularly once or twice a year.

If the specifications are not met in the performance tests, please contact the Service Department of Anritsu Corporation.

5.2 Instruments Required for Performance Test

The instruments required for performance tests are shown below.

Instruments Required for Performance Test

Check item		Measuring instrument	Recommended instrument name (model name)	Reference paragraph
AF oscillator	Output level accuracy and waveform distortion	AF level meter and AF distortion rate meter	8903B (HP)	5.3.1.1
Audio analyzer	AF level measurement accuracy	AF oscillator	8903B (HP)	5.3.2.1

5.3 Performance Tests

Do not start the performance tests until the equipment to be tested and the measuring instruments have warmed up for at least 30 minutes and option 01 analog measurement of the MT8801C is completely stabilized. Keep AC supply voltage fluctuations, noise, vibration, dust, humidity and any other factor which could affect results to a minimum.

5.3.1 AF oscillator

5.3.1.1 Output level accuracy and waveform distortion

(1) Specifications

Accuracy:

Unbalanced output: ± 0.5 dB

Floating output: ± 2 dB (frequency : 1 kHz, output level ≥ 1 mV)

Unbalanced output: ± 1 dB (20 Hz \leq frequency ≤ 20 kHz, output level ≥ 1 mV)

Measured at < 30 kHz bandwidth

Waveform distortion:

< -50 dBc (frequency : 1 kHz, output level : 1 V)

< -45 dBc (20 Hz \leq frequency ≤ 20 kHz, output level : 1 V)

Measured at < 30 kHz bandwidth

(2) Test instrument

AF level meter and AF distortion rate meter: 8903B

(3) Note on test

Set the bandwidth of the AF level meter and AF distortion rate meter to less than 30 kHz.

(4) Setup

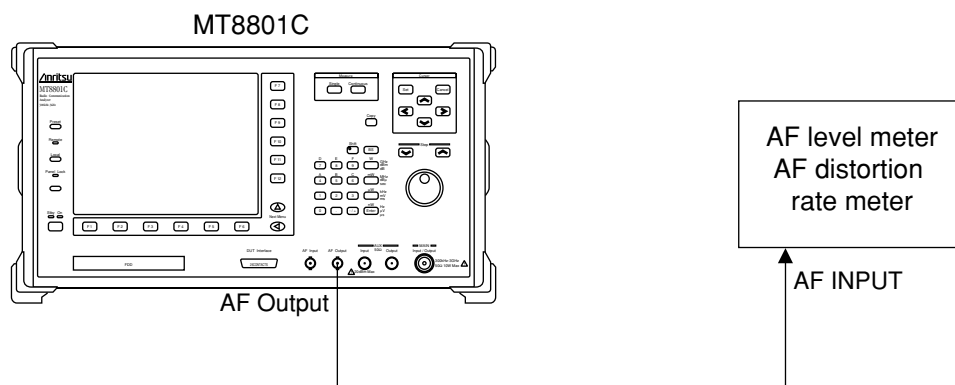

Section 5 Performance Tests

(5) Test procedures

Step	Procedure
------	-----------

Output level accuracy

1. Set the AF level output impedance on the Setup Common Parameter screen.
2. Set the MT8801C to TX Measure (Analog) mode.
3. Specify AF OSC.1:Tone and the AF frequency for the MT8801C.
(If AF OSC.2 is ON, set it to OFF.)
4. Set the AF level of AF OSC.1 and read the value indicated on the AF level meter.
5. Change the AF level of AF OSC.1 in accordance with the table below, and repeat the measurement.

Output level accuracy of AF oscillator

AF level set value (V)	0.001	0.01	0.1	0.3	1	3
Level measured value (V)						

(AF level output Impedance=600Ω)

Waveform distortion

1. Set the MT8801C to TX Measure (Analog) mode.
2. Specify OSC.1:Tone, Level = 1V, and AF Frequency for the MT8801C.
(If AF OSC.2 is ON, set it to OFF.)
3. Read the value indicated on the AF distortion rate meter.
4. Change the AF frequency of MT8801C AF OSC.1 in accordance with the table below, and repeat the measurement.

Waveform distortion of AF oscillator

AF Frequency (kHz)	0.02	0.3	1	3	10	20
Waveform distortion (dB)						

5.3.2 Audio analyzer

5.3.2.1 AF level measurement accuracy

(1) Specifications

Frequency range: 30 Hz to 20 kHz
 Input level range: 1 mV rms to 30 V rms
 Accuracy: ± 0.5 dB

(2) Test instrument

AF oscillator: 8903B

(3) Setup

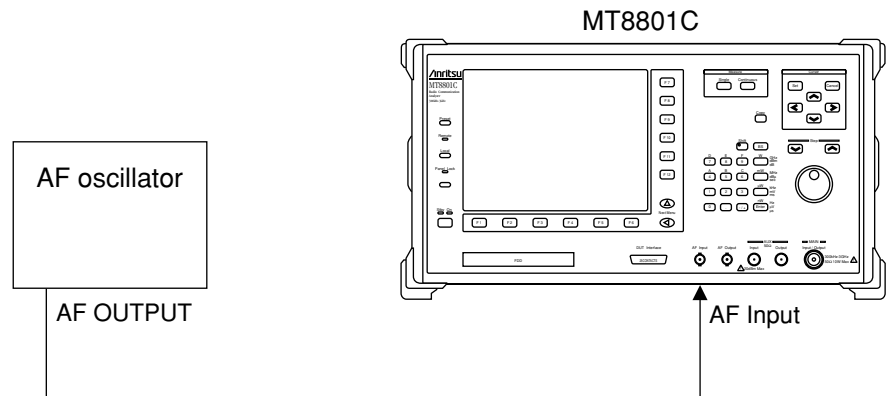

(4) Test procedures

Step	Procedure
1.	Set the MT8801C to RX Measure (Analog) mode.
2.	Specify the AF oscillator level.
3.	Specify the AF oscillator frequency and read the AF level value indicated on the MT8801C.
4.	Change the frequency of the AF oscillator in accordance with the table below, and repeat the measurement.

AF level measurement accuracy of audio analyzer

Frequency (kHz)	0.03	0.1	0.3	1	3	10	20
AF Level (V)							

Section 5 Performance Tests

5.3.3 Example of performance test result entry sheet

This paragraph gives an example of sheets used to summarize the results of a performance test on Options 10/11: Audio Test of the MT8801C.

Use a copy of this sheet for the performance test.

Test site _____ Report No. _____
 _____ Date _____
 _____ Tested by _____

Device name: MT8801C Radio Communication Analyzer
 MX880115A GSM Measurement Software

Production lot No. _____ Ambient temperature _____ °C
 Power frequency _____ Hz Relative humidity _____ %

Remarks _____

AF oscillator

Output level accuracy

AF level set value (V)	0.001	0.01	0.1	0.3	1	3
Level measured value (V)						

(AF level output Impedance=600Ω)

Audio analyzer

AF level measurement accuracy

Frequency (kHz)	0.03	0.1	0.3	1	3	10	20
AF Level (V)							

Section 6 Calibration

This section describes the measuring instruments required to calibrate the MT8801C, and the setup and calibration method for these instruments.

6.1	Calibration Requirements	6-2
6.2	Equipment Required for Calibration	6-2
6.3	Calibration	6-3
6.3.1	Calibrating the reference crystal oscillator	6-3

6.1 Calibration Requirements

Calibration is done to help maintain the MT8801C’s performance.

Calibration should be performed periodically even if the MT8801C is operating normally.

We recommend that the MT8801C be calibrated once or twice a year.

Contact the Service Department of Anritsu Corporation if the MT8801C fails to meet the specifications during calibration.

6.2 Equipment Required for Calibration

The table below shows the equipment required to calibrate each item.

Table 6-1 Equipment Required for Calibration

Recommended equipment	Required performance†	Calibration item
Frequency counter (MF1603A)	<ul style="list-style-type: none"> • 100 KHz to 3 GHz • Resolution: 1 Hz • External reference input: 10 MHz 	Frequency accuracy of reference
Frequency standard	Standard radio-wave receiver or equipment having equivalent function (accuracy better than 1×10^{-9})	Frequency accuracy of reference crystal oscillator

† Extracts part of performance which can cover the measurement range of the test item.

6.3 Calibration

Do not start the performance tests until the MT8801C and measuring instruments have warmed up for at least 24 hours and they have stabilized completely. To obtain the best measurement accuracy, do the calibration at room temperature. Keep AC power voltage fluctuations, noise, vibration, dust, humidity, and any other factors which can affect results to a minimum.

6.3.1 Calibrating the reference crystal oscillator

The stability of the MT8801C reference crystal oscillator is $\pm 2 \times 10^{-8}$ /day. Calibrate the frequency of the reference crystal oscillator by using a reference signal generator generating a reference signal that is either locked to a standard wave or to the sub-carrier of a TV broadcast on a color TV (the sub-carrier will be locked to a rubidium atomic standard).

(1) Specifications

Reference oscillator	Frequency	Aging rate	Temperature characteristics
Standard type (after 24-hour operation)	10 MHz	2×10^{-8} /day	$\pm 5 \times 10^{-8}$ (0 to 50 °C)

(2) Instruments required for calibration

- Frequency counter: 10 MHz external reference input, resolution: 1 Hz
- Frequency standard: Standard radio-wave receiver or equipment having equivalent function
(accuracy better than 1×10^{-9})

(3) Setup

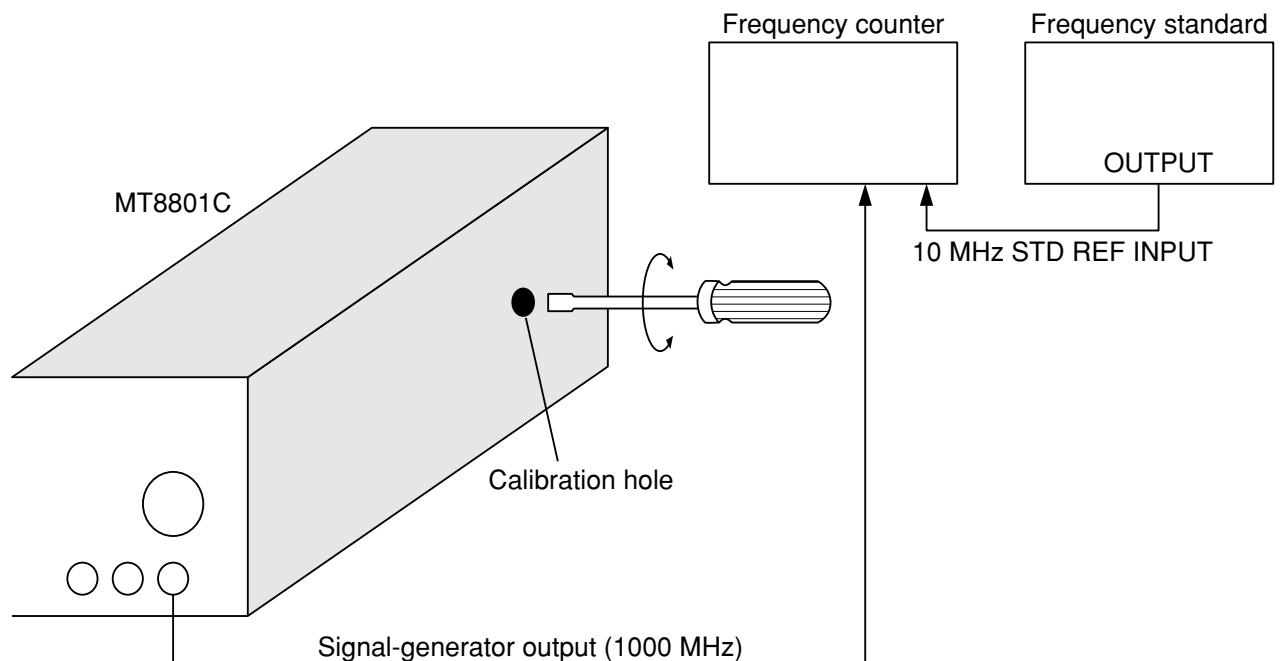

Section 6 Calibration

(4) Calibration procedure

Step	Procedure
1.	Setup the equipment as shown in the figure above. The ambient temperature must be $23\text{ }^{\circ}\text{C} \pm 5\text{ }^{\circ}\text{C}$.
2.	Set the Power switch on the rear panel to On and the Power switch on the front panel to the Standby position. Then, allow the MT8801C reference crystal oscillator to warm-up for 24 hours.
3.	Set the Power switch on the MT8801C front panel to On.
4.	Apply the standard frequency signal to the external reference input of the frequency counter.
5.	Set the frequency of the signal generator of the MT8801C to 1000.000 000 MHz, the level to -28 dBm , and the modulation to off.
6.	Adjust the calibration trimmer of the crystal oscillator so that the frequency-counter reading is $1\text{ 000.000 000 MHz} \pm 10\text{ Hz}$.

Section 7 Storage and Transportation

This section describes the long-term storage, repacking, and transportation of the MT8801C and the regular maintenance procedures.

7.1	Cleaning the Cabinet	7-2
7.2	Storage Precautions	7-3
	7.2.1 Precautions before storage	7-3
	7.2.2 Recommended storage conditions	7-3
7.3	Repacking and Transportation	7-4
	7.3.1 Repacking	7-4
	7.3.2 Transportation	7-4

7.1 Cleaning the Cabinet

Always turn the MT8801C power switch OFF and disconnect the power plug from the AC power inlet before cleaning the cabinet. To clean the external cabinet:

- Use a soft, dry cloth.
- Use a cloth moistened with diluted neutral cleaning liquid if the instrument is very dirty or before long-term storage. Then, use a soft, dry cloth to wipe the instrument dry.
- If loose screws are found, tighten them with the appropriate tools.

CAUTION

Never use benzine, thinner, or alcohol to clean the cabinet; these chemicals may damage the coating or cause deformation or discoloration.

7.2 Storage Precautions

This paragraph describes the procedures for long-term storage of the MT8801C.

7.2.1 Precautions before storage

- (1) Before storage, wipe dust, finger-marks, and other contaminants off the MT8801C.
- (2) Avoid storing the MT8801C where it may be exposed to:
 - 1) Direct sunlight or high dust levels.
 - 2) High humidity.
 - 3) Active gasses or acid.
 - 4) The following temperatures or humidity:
 - Temperature: > 60 °C, <20 °C
 - Humidity: ≥ 90 %

7.2.2 Recommended storage conditions

The recommended storage conditions are as follows:

- Temperature: 0 to 30 °C
- Humidity: 40 % to 80 %
- Stable temperature and humidity over a 24-hour period.

7.3 Repacking and Transportation

Take the following precautions if the MT8801C must be returned to Anritsu Corporation for servicing.

7.3.1 Repacking

Use the original packing materials. If the MT8801C is packed in other materials, observe the following packing procedure:

- (1) Wrap the MT8801C in a plastic sheet or similar material.
- (2) Use a cardboard box, wooden box, or aluminum case which allows shock-absorbing material to be inserted on all sides of the MT8801C.
- (3) Use enough shock-absorbing material to protect the MT8801C during transportation and to prevent it from moving in the container.
- (4) Secure the container with packing straps, adhesive tape, or bands.

7.3.2 Transportation

Do not subject the MT8801C to severe vibration during transport. Also, transport under the storage conditions recommended in paragraph 7.2.

Appendix

Appendix A Screen/ Function Key Change Figure	A-1
Appendix B List of Initial Values	B-1
Appendix C Index	C-1

Appendix A Screen/ Function Key Change Figure

The change of screen and the change of function keys for each screen of Options 10/
11 : Audio Test are illustrated in the figure.

[Screen Change] Refer to Para. 3.2.

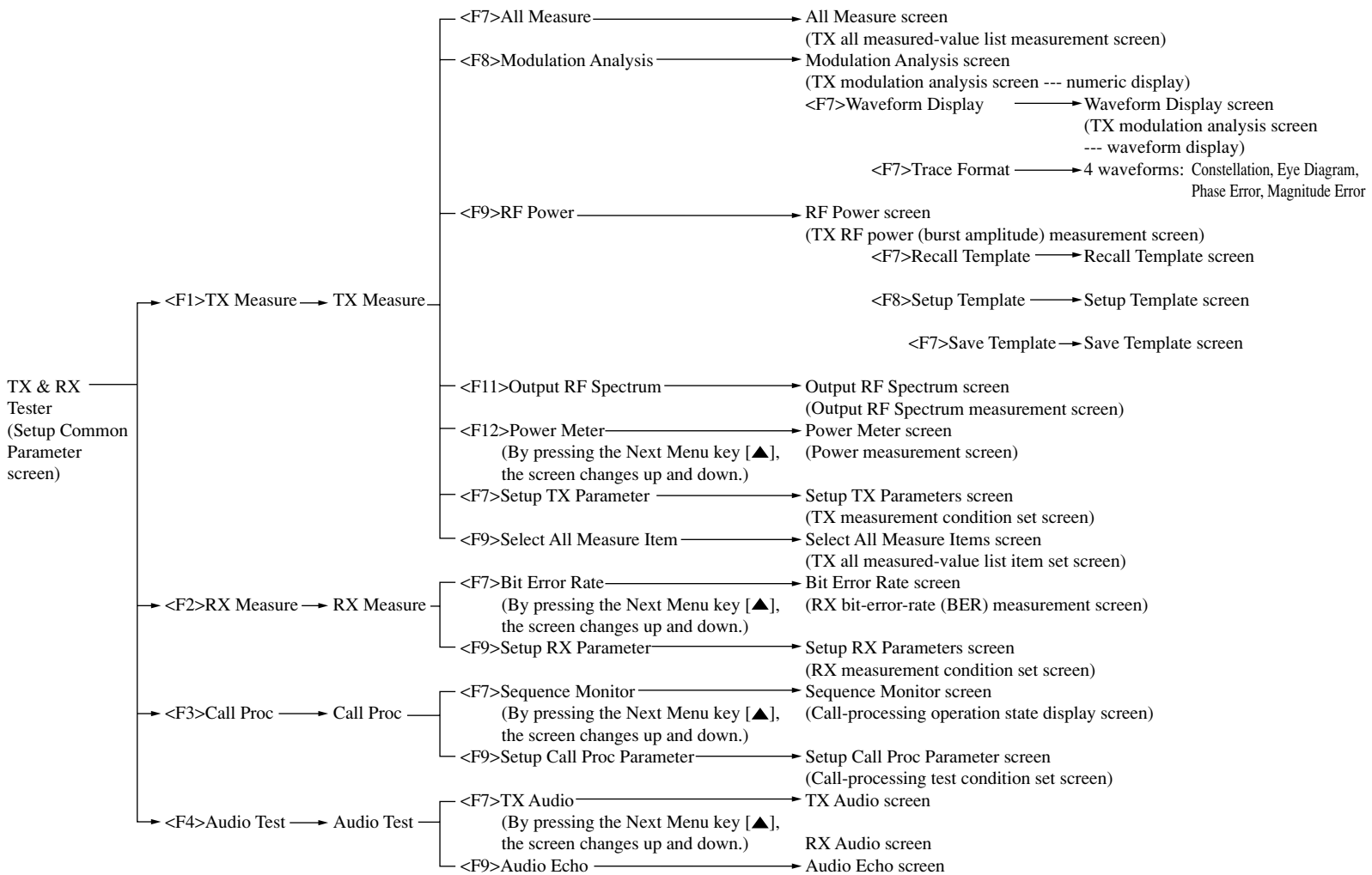

Appendix A Screen/ Function Key Change Figure

[Change of function keys for each screen]

Note:

When (Back Screen) or (Return) of F12 at the bottom of the displayed function keys is selected, the screen returns to the upper screen.

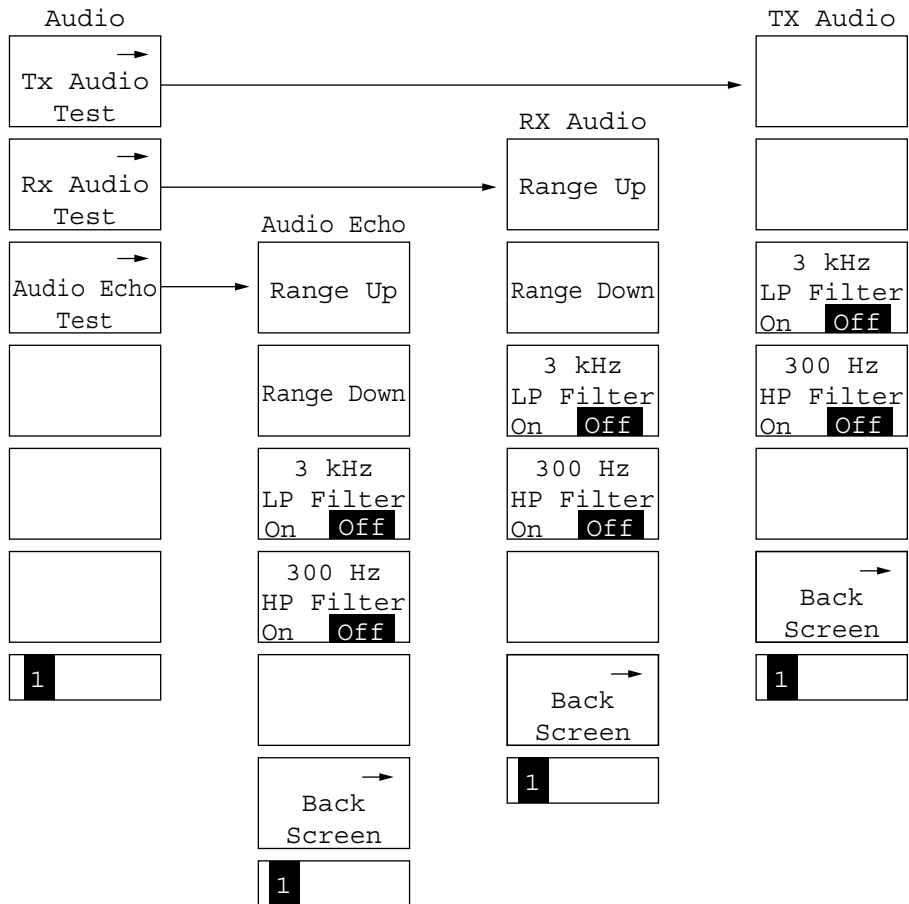

Appendix B List of Initial Values

- Initial values are the values at the time of shipping from the factory.
- The items marked with an asterisk are those which are not indicated or selected by default.
- PS in the “Initialization” column on the right end of the table means an item which is initialized by the [Preset] key on the panel and “PRE” “INI” remote control command. PW in the same column means an item which is initialized by the “RST” remote control command. An item which is initialized by the “PRE” or “INI” command can be initialized also by the “RST” command.
- An item which is not initialized by either method is marked “NO”.

The initial values of the MT8801C Options 10/11: GSM Audio Test is shown below.

• TX Audio screen

Item	Initial value	Initialization
AF Frequency	1 kHz	PW
AF Level	100 mV	PW
3 kHz LP Filter On/Off	Off	PW
300 Hz HP Filter On/Off	Off	PW

• RX Audio screen

Item	Initial value	Initialization
AF Frequency	1 kHz	PW
AF Level	100 mV	PW
3 kHz LP Filter On/Off	Off	PW
300 Hz HP Filter On/Off	Off	PW

• Audio Echo screen

Item	Initial value	Initialization
AF Frequency	1 kHz	PW
AF Level	100 mV	PW
3 kHz LP Filter On/Off	Off	PW
300 Hz HP Filter On/Off	Off	PW

Appendix B List of Initial Values

Appendix C Index

The numbers on the right indicate section and paragraph numbers in this operation manual.

AF Input/Output connectors	3.1, 4.3.1
AF Measure	3.2.1,
Analog Tester	3.2
Audio Echo measurement	3.2.1, 4.3.3, 4.7
Audio Echo screen	3.2.2 (4)
AUX Input/Output connectors	3.1, 4.2 (1), 4.3.1
Average Count	4.2 (1)
Alternate key	2.2.2
Allowable maximum power	4.10
Crystal oscillator stability	1.5
Compensation for RF cable loss at TX measurement	4.2 (1)
Delete File	4.9
Demod Output connector	3.1
Display Dir	4.8, 4.9
DUT Interface connector	3.1, 4.3.1
Echo back	4.4
Entering title	2.5.1
Error messages at measurement	4.2 (1)
Equipment configuration	3.2.1
Ext FM Input connector	3.2.1
Fan clearance	2.1
Format	4.9
Frame Noise measurement	4.5, 4.6
GPIB	3.1, 4.11
Hard Copy	4.10
Handling FD	2.5
Handling storage media	3.1, 4.1.1
Inputting item and data	4.3.2
Input/output connectors	3.1, 4.2 (1), 4.3
Installation site and environmental conditions	2.1
LCD display	3.1, 4.2
Loop back	4.4
Main Input/Output connector	3.1, 4.2 (1), 4.3.1
Manual Calibration	4.2 (1)
Manual composition	1.2
Maximum power to connectors	2.2.2
Operating file	4.9
Overview of functions	3.2.2 (3), 4.2 (3)
Overview of functions	3.2.1
Precaution before storage	7.2.1
Protective grounding	2.3.1, 3.1, 4.1

Appendix C Index

Preparation before power-on	2.3
Recall	4.8
Receiver(RX) measurement	7.2.2
Recommended storage conditions	1.1
Reference crystal oscillator	4.1.1
Repacking and transportation for servicing	7.3
Replacing fuse	2.3.2
RS232C	3.1, 4.11
RX Audio measurement	3.2.1, 4.6
RX Audio screen	3.2.2 (4), 4.6
RX Measure	3.2.1
Save	4.8
Selection of GSM test mode	3.2.2 (1)
Serial	3.1
Setup Common Parameter(Option 10/11)	4.4
Safety measure	4.1 (2)
Setup state after power-on	4.1.3
Saving/recalling parameter and data	4.8
Safety measures for power supply	2.2.1
Specifications	1.3
Settings relating to remote control and panel key control ...	4.11
TX Audio measurement	3.2.1, 4.5
TX Audio screen	3.2.2 (4), 4.5
TX Measure	3.2.1
Turning on and off	4.1
User Cal Factor	4.2 (1)
User calibration	4.2 (1)
Write Protect	2.2

MT8801C

Radio Communication Analyzer

Option 10/11: Audio Test

Operation Manual

(Remote Control)

Table of Contents

Section 1 General	1-1
1.1 General Description	1-2
1.2 Remote Control Functions	1-2
1.3 Example of System Configuration Using RS-232C/GPIB	1-3
1.4 RS-232C Specifications	1-4
1.5 GPIB Specifications	1-4
Section 2 Device Messages	2-1
2.1 General Description	2-2
2.2 Suffix Code	2-3
2.3 IEEE488.2 Common Commands and Supported Commands	2-4
2.4 Status Messages	2-6
2.5 GPIB Commands of Option 10/11 Audio Test	2-8
Section 3 Setup	3-1
3.1 Connecting Devices with GPIB Cables	3-2
3.2 Setting GPIB Interface Conditions	3-3
3.3 Connection of RS-232C Interface Signal	3-4
3.4 Setting RS-232C Interface Conditions	3-5
3.5 Setting the Items Relating to Remote Control and Panel Key Control	3-6
Section 4 Device Message Format	4-1
4.1 General Description	4-2
4.2 Program Message Format	4-3
4.3 Response Message Format	4-7

Section 5 Status Messages	5-1
5.1 IEEE488.2 Standard Status Model	5-2
5.2 Status Byte (STB) Register	5-4
5.3 Enabling the Service Request (SRQ)	5-8
5.4 Standard Event Status Register	5-9
5.5 Extended Event Status Register	5-12
5.6 Techniques for Synchronizing the MT8801C with a Controller	5-16
 Section 6 Initial Settings	 6-1
6.1 General Description	6-2
6.2 Bus Initialization by the IFC Statement	6-3
6.3 Initialization for Message Exchange by DCL and SDC Bus Commands	6-4
6.4 Device Initialization by the *RST Command	6-5
6.5 Device Initialization by the PRE/INI/IP Command	6-6
6.6 Device Status at Power-on	6-7
 Section 7 Sample Program	 7-1
7.1 Notes on creating Program	7-2
 Appendix	 App-1
Appendix A ASCII Code Table	A-1
Appendix B Comparison Table of Controllers' GPIB Instructions	B-1
Appendix C Index	C-1

Section 1 General

This section outlines the Remote Control functions of the MT8801C Radio Communication Analyzer.

- 1.1 General Description 1-2
- 1.2 Remote Control Functions 1-2
- 1.3 Example of System Configuration Using
RS-232C/GPIB 1-3
- 1.4 RS-232C Specifications 1-4
- 1.5 GPIB Specifications 1-4

1.1 General Description

The MT8801C Radio Communication Analyzer, when combined with an external controller, can automate your measurement system. For this purpose, the MT8801C is equipped with an RS-232C interface port and a GPIB interface bus (IEEE Std 488.2-1987) as a standard feature.

1.2 Remote Control Functions

The Remote Control functions of the MT8801C are as follows:

- (1) Controls all functions except the power switch, floppy disk unloading, and some keys including the [Local] key
- (2) Reads out all setting conditions
- (3) Sets the RS-232C interface conditions and GPIB address from the panel
- (4) Executes interrupts and serial polling

These functions enable to configure the automatic measurement system when the MT8801C is combined with a personal computer and other measuring instruments.

1.3 Example of System Configuration Using RS-232C/GPIB

(1) Control by the host computer (1)

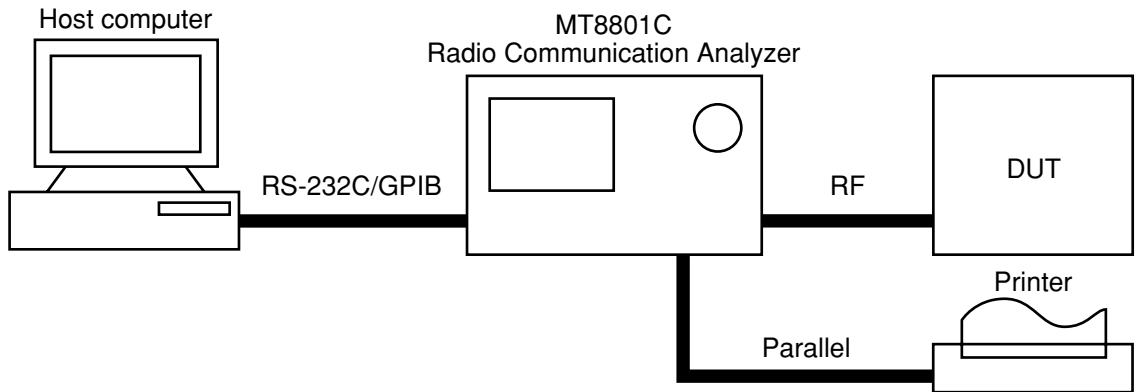

(2) Control by the host computer (2)

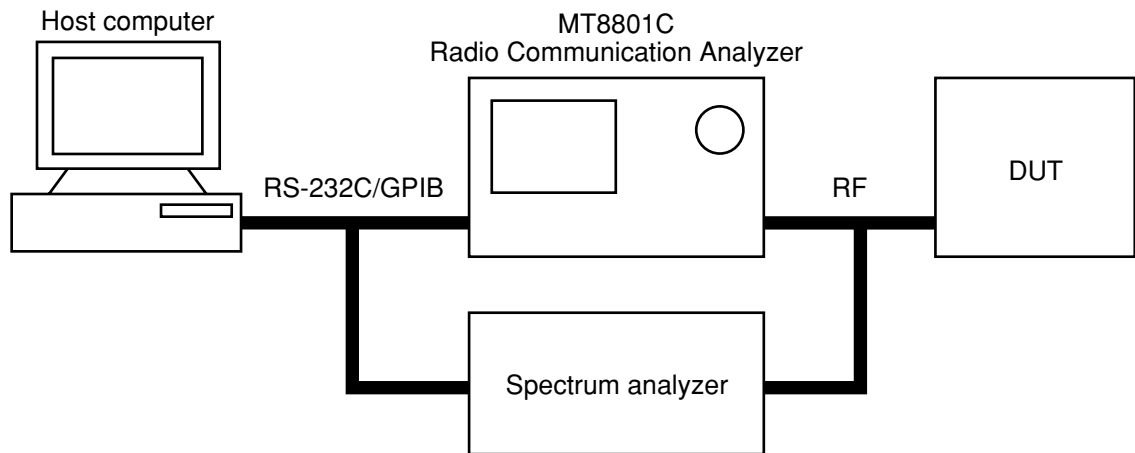

1.4 RS-232C Specifications

The RS-232C specifications of the MT8801C are shown in the table below.

Item	Specification
Function	Control from an external controller (except power switch)
Communication system	Asynchronous (start-stop method), half-duplex
Communication control	X-ON/OFF control
Baud rate	1200, 2400, 4800, 9600 bps
Data bits	7 bits, 8 bits
Parity	Odd, Even, None
Start bit	1 bit
Stop bit	1 bit, 2 bits
Connector	D-sub 9 pins, female

1.5 GPIB Specifications

The GPIB of the MT8801C provides the IEEE488.1 interface function subsets listed in the table below.

GPIB Interface Functions

Code	Interface function
SH1	All source handshake functions are provided. Synchronizes the timing of data transmission.
AH1	All acceptor handshake functions are provided. Synchronizes the timing for receiving data.
T6	Synchronizes the timing for receiving data. The serial poll function is provided. The talk-only function is not provided. The talker can be canceled by MLA.
L4	Basic listener functions are provided. The listen-only function is not provided. The listener can be canceled by MTA.
SR1	All service request and status byte functions are provided.
RL1	All remote/local functions are provided. The local lockout function is provided.
PP0	Parallel poll functions are not provided.
DC1	All device clear functions are provided.
DT1	The device trigger function is provided.
C0	Controller functions are not provided.

Section 2 Device Messages

This section outlines and lists the device messages of the Option 10/11 Audio Test of the MT8801C.

2.1	General Description	2-2
2.2	Suffix Code	2-3
2.3	IEEE488.2 Common Commands and Supported Commands	2-4
2.4	Status Messages	2-6
2.5	GPIB Commands of Option 10/11 Audio Test	2-8

2.1 General Description

A device message is a data message transmitted between the controller and device via the system interface. Device messages are classified into program messages and response messages.

A program message is an ASCII data message transferred from the controller to the device. Program messages are classified into program commands and program queries.

Program commands are classified into device-specific commands used exclusively to control the MT8801C, and IEEE488.2 common commands. IEEE488.2 common commands are also used for other measuring instruments conforming to IEEE488.2 connected to the bus.

A program query is a command used to obtain a response message from the device. It is transferred from the controller to the device in advance, then the controller receives the response message from the device.

A response message is an ASCII data message transferred from the device to the controller.

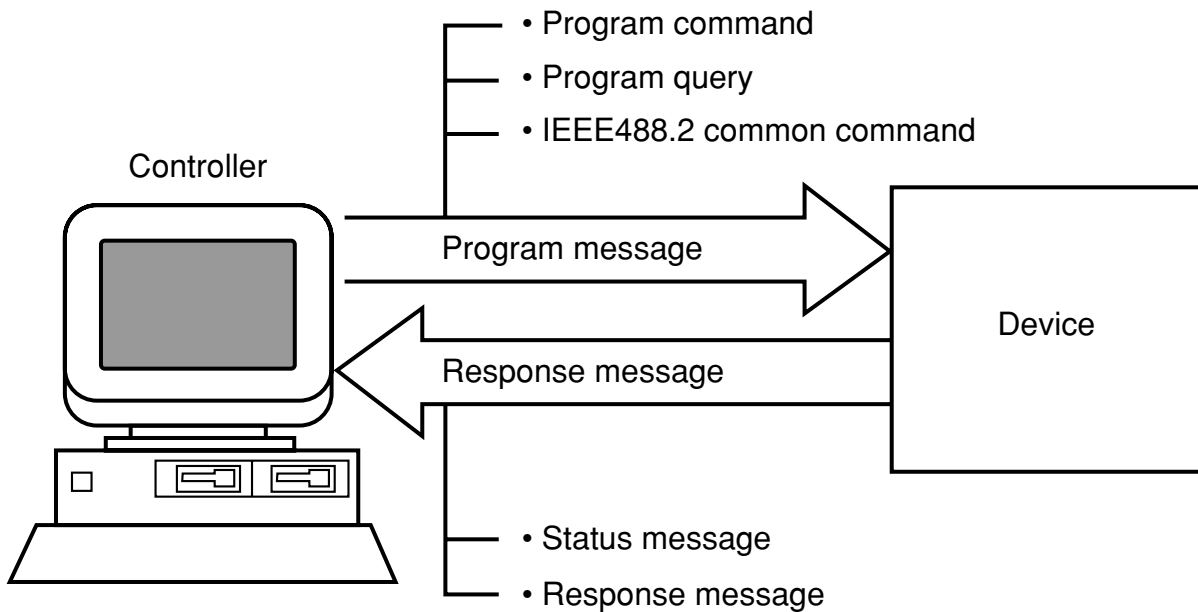

Program messages and response messages may have a suffix (units) at the end of the numeric data.

2.2 Suffix Code

The table below shows the suffixes used for the MT8801C.

MT8801C Suffix Codes

Type	Unit	Suffix code
Frequency	GHz	GHZ, GZ
	MHz	MHZ, MZ
	kHz	KHZ, KZ
	Hz	HZ
	Default	HZ
Time	second	S
	m second	MS
	μ second	US
	Default	MS
Level (dB)	dB	DB
	dBm	DBM, DM
	dB μ	DBU
	Default	Determined in conformance with the set scale unit
Level (W)	W	W
	mW	MW
	μ W	UW
	nW	NW
	Default	UW

2.3 IEEE488.2 Common Commands and Supported Commands

The table below lists 39 common commands specified in the IEEE488.2 standard. IEEE488.2 common commands which are supported by the MT8801C are indicated with the ☉ symbol in the table.

Mnemonic	Command name	IEEE488.2 standard	MT8801C supported commands
*ADD	Accept Address Command	Optional	
*CAL	Calibration Query	Optional	
*CLS	Clear Status Command	Mandatory	☉
*DDT	Define Device Trigger Command	Optional	
*DDT?	Define Device Trigger Query	Optional	
*DLF	Disable Listener Function Command	Optional	
*DMC	Define Macro Command	Optional	
*EMC	Enable Macro Command	Optional	
*EMC?	Enable Macro Query	Optional	
*ESE	Standard Event Status Enable Command	Mandatory	☉
*ESE?	Standard Event Status Enable Query	Mandatory	☉
*ESR?	Standard Event Status Register Query	Mandatory	☉
*GMC?	Get Macor contents Query	Optional	
*IDN?	Identification Query	Mandatory	☉
*IST?	Individual Status Query	Optional	
*LMC?	Learn Macro Query	Optional	
*LRN?	Learn Device Setup Query	Optional	
*OPC	Operation Complete Command	Mandatory	☉
*OPC?	Operation Complete Query	Mandatory	☉
*OPT?	Option Identification Query	Optional	
*PCB	Pass Control Back Command	Mandatory if other than C0	
*PMC	Purge Macro Command	Optional	
*PRE	Parallel Poll Register Enable Command	Optional	
*PRE?	Parallel Poll Register Enable Query	Optional	
*PSC	Power On Status Clear Command	Optional	
*PSC?	Power On Status Clear Query	Optional	
*PUD	Protected User Data Command	Optional	
*PUD?	Protected User Data Query	Optional	
*RCL	Recall Command	Optional	
*RDT	Resource Description Transfer Command	Optional	
*RDT?	Resource Description Transfer Query	Optional	
*RST	Reset Command	Mandatory	☉
*SAV	Save Command	Optional	
*SRE	Service Request Enable Command	Mandatory	☉
*SRE?	Service Request Enable Query	Mandatory	☉
*STB?	Read Status Byte Query	Mandatory	☉
*TRG	Trigger Command	Mandatory if DT1	☉
*TST?	Self Test Query	Mandatory	☉
*WAI	Wait to Continue Command	Mandatory	☉

Note:

2.3 IEEE488.2 Common Commands and Supported Commands

Table below lists the IEEE488.2 common commands used in the MT8801C.

IEEE488.2 common command				
Command name	Program Msg	Query Msg	Response Msg	Remarks
Clear status	*CLS	—	—	
Standard event status enable	*ESE n	*ESE?	n	n:0 to 255
Standard event status register	—	*ESR?	n	n:0 to 255
Identification query	—	*IDN?	id	ID:Manufacturer name, model name, etc.
Operation complete	*OPC	*OPC?	1	
Reset	*RST	—	—	
Service request enable	*SRE	*SRE?	n	"n:0 to 63,128 to 191"
Read status byte	—	*STB?	n	
Trigger	*TRG	—	—	
Self test	—	*TST?	n	
Wait to continue	*WAI	—	—	

2.4 Status Messages

The diagram below shows the structure of service-request summary messages for the status byte register (STB) used with the MT8801C.

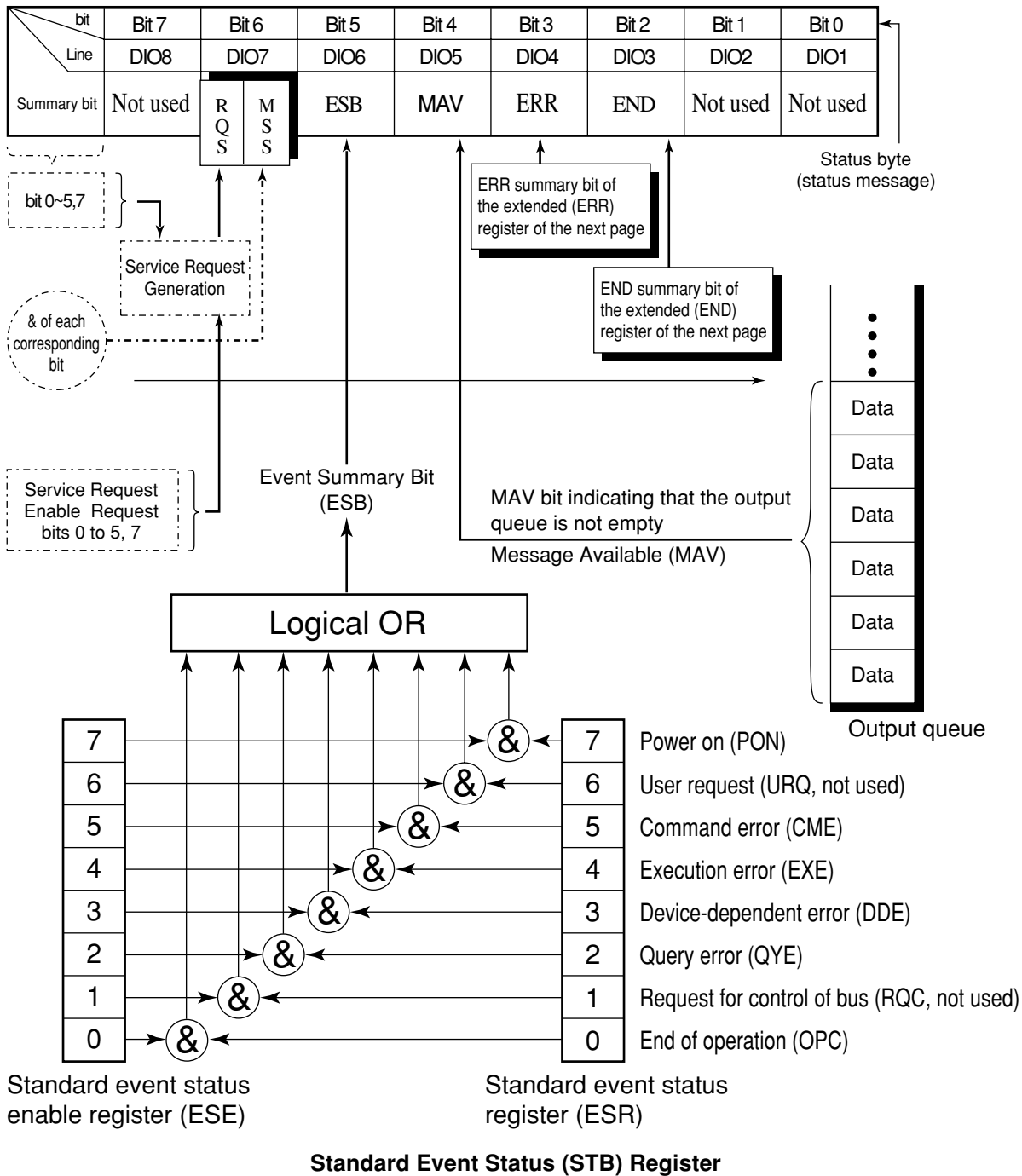

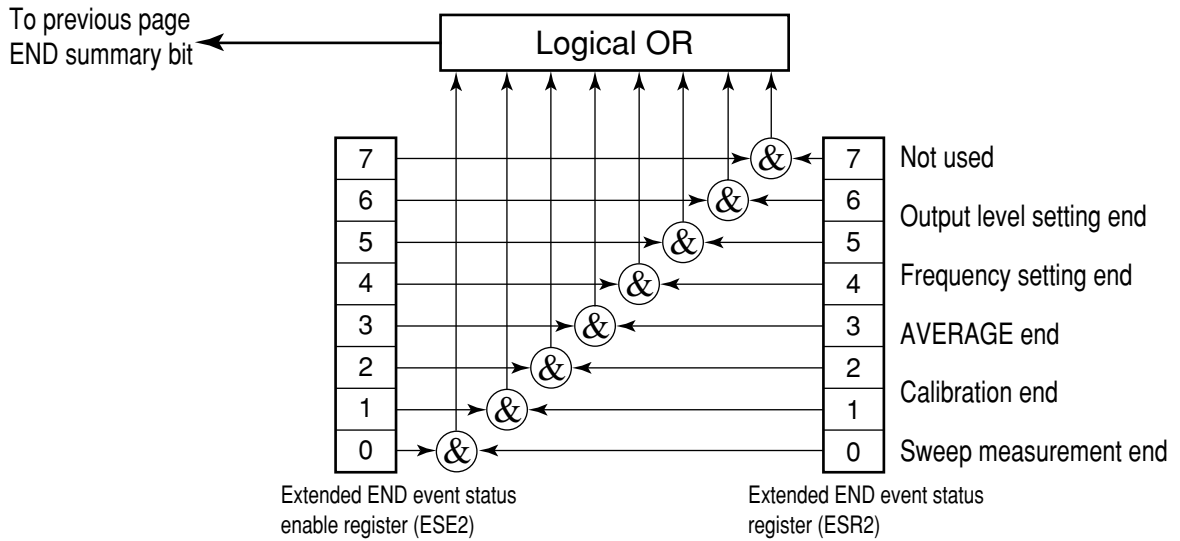

Extended Event Status (END) Register

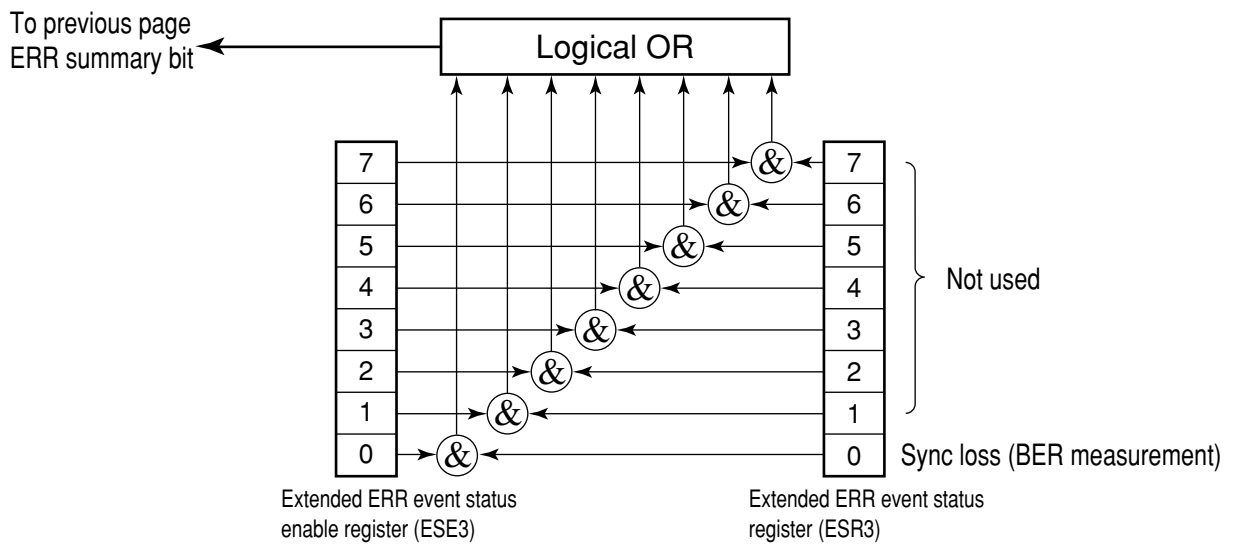

Extended Event Status (ERR) Register

2.5 GPIB Commands of Option 10/11 Audio Test

This paragraph describes the GPIB commands of Audio Test. For other GPIB commands, see the operation manuals of MX880115A GSM Measurement Software and MT8801C Option 01: Analog Measurement.

• **Device message table**

(a) Program messages (Program Msg)/query message (Query Msg)

- (i) Uppercase characters : Reserved words
- (ii) Numeric : Reserved words (numeric code)
- (iii) Lowercase characters in argument
 - f (frequency) : Real number or integer with decimal point
 - Units : GHZ, MHZ, KHZ, HZ, GZ, MZ, KZ, no units = HZ
 - t (time) : Real number or integer with decimal point
 - Units : S, SC, MS, US, no unit = US
 - ℓ (level) : Real number or integer with decimal point
 - Units : DB, DBM, DM, DBU, W, MW, UW, NW, no units = set SCALE units
 - n (no units integer) : Integer
 - r (no units real number) : Real number
 - h (no units hexadecimal number) : Hexadecimal number
 - Others : Listed in remarks columns of the table

(b) Response messages (Response Msg)

- (i) Uppercase characters : Reserved words
- (ii) Numeric : Reserved words (numeric code)
- (iii) Lowercase characters in argument
 - f (frequency) : 12-character fixed integerunits = HZ
 - t (time) : Real number or integer with decimal point
 - ℓ (level) : Real number or integer with decimal point
 - u (ratio) : Real number or integer with decimal point
 - s (symbol) : Real number or integer with decimal point
 - n (no units integer) : Integer, variable number of digits (Significant digits are output.)
 - r (no units real number) : Real number with decimal point, variable number of digits (Significant digits are output.)
 - h (no units hexadecimal number) : Hexadecimal number
 - Others : Written in remarks columns of the table

Notes:

- Integer:NR1 format, real number:NR2 format
- 0/:Zero

2.5 GPIB Commands of Option 10/11 Audio Test

(1) Audio Echo screen commands

Intermediate class	Function	Function details	Program Msg	Query Msg	Response Msg	Remarks	
Audio Echo	Screen change		MEAS AUEC	MEAS?	AUEC		
	AF Frequency		AUECFREQ f	AUECFREQ?	f		
	AF Level		AUECLVL 1	AUECLVL?	1		
	AF Range	Up		AUECRNG UP			
		Down		AUECRNG DN			
		30 V		AUECRNG2			
		4 V		AUECRNG3			
		400 mV		AUECRNG4			
		40 mV		AUECRNG5			
	LP Filter	On		AUECLP ON	AUECLP?	ON	
		Off		AUECLP OFF	AUECLP?	OFF	
	HP Filter	On		AUECHP ON	AUECHP?	ON	
		Off		AUECHP OFF	AUECHP?	OFF	
	Measure result	AF Frequency			AUECMFREQ?	f	
AF Level				AUECMLVL?	1		

(2) TX Audio screen commands

Intermediate class	Function	Function details	Program Msg	Query Msg	Response Msg	Remarks	
TX Audio	Screen change		MEAS TXAU	MEAS?	TXAU		
	AF Frequency		TXAUFREQ f	TXAUFREQ?	f		
	AF Level		TXAULVL 1	TXAULVL?	1		
	LP Filter	On		TXAULP ON	TXAULP?	ON	
		Off		TXAULP OFF	TXAULP?	OFF	
	HP Filter	On		TXAUHP ON	TXAUHP?	ON	
		Off		TXAUHP OFF	TXAUHP?	OFF	
	Measure result	AF Frequency			TXAUMFREQ?	f	
		AF Level			TXAUMLVL?	1	

Section 2 Device Messages

(3) RX Audio screen commands

Intermediate class	Function	Function details	Program Msg	Query Msg	Response Msg	Remarks
	Screen change		MEAS RXAU	MEAS?	RXAU	
	AF Frequency		RXAUFREQ f	RXAUFREQ?	f	
	AF Level		RXAULVL 1	RXAULVL?	1	
	AF Range	Up	RXAURNG UP			
		Down	RXAURNG DN			
		30 V	RXAURNG2			
		4 V	RXAURNG3			
		400 mV	RXAURNG4			
		40 mV	RXAURNG5			
		LP Filter	On	RXAULP ON	RXAULP?	ON
	Off		RXAULP OFF	RXAULP?	OFF	
	HP Filter	On	RXAUHP ON	RXAUHP?	ON	
		Off	RXAUHP OFF	RXAUHP?	OFF	
	Measure result	AF Frequency		RXAUMFREQ?	f	
		AF Level			RXAUMLVL?	1

Section 3 Setup

This section describes the RS-232C/GPIB connections to external devices and setting the remote-control interface of the MT8801C.

3.1	Connecting Devices with GPIB Cables	3-2
3.2	Setting GPIB Interface Conditions	3-3
3.3	Connection of RS-232C Interface Signal	3-4
3.4	Setting RS-232C Interface Conditions	3-5
3.5	Setting the Items Relating to Remote Control and Panel Key Control	3-6
3.5.1	Remote control and panel control keys	3-6
3.5.2	Remote control status	3-6

3.1 Connecting Devices with GPIB Cables

The rear panel has connectors for connecting GPIB cables.

Up to 15 devices, including the controller, can be connected to one system. Connect devices under the conditions described to the right of the diagram below.

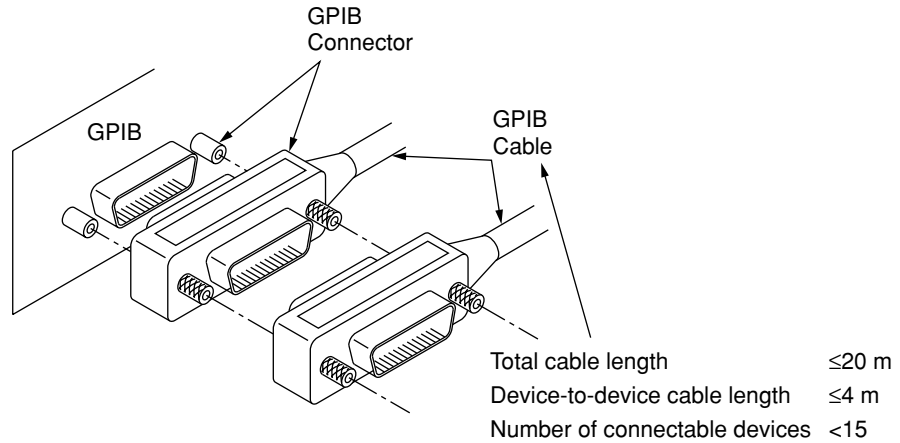

Mounting and dismounting of the GPIB cable must be done after turning off the power switch and pulling out the power cord from the socket. If the power remains on, only signal common line may disconnected before the other lines, then AC leak voltages are applied to the ICs, and there is a possibility that components such as ICs in the interface unit will be damaged.

CAUTION

The GPIB cables must be connected before the power is turned on.

3.2 Setting GPIB Interface Conditions

Set the GPIB interface on the Instrument Setup screen at the front panel.

Set the following items:

- (1) Interface: Connect to Controller (Initial value: GPIB)
- (2) GPIB: Address (Initial value: 01)

An example of the setting when the GPIB interface is set with the GPIB address 03 is given below.

Step	Key operation	Explanation
(Switching to the Instrument Setup screen)		
1.	[Main Func on off] F6	Sets the Main Func on to display the main menu.
2.	Next Menu[◀]	Sets the Instrument Setup mode.
	[Instrument Setup] F2	Displays the Instrument Setup screen.
(Selecting the remote control interface)		
3.	Cursor [▲] [▼]	Uses these cursor keys to select "Interface Connect to Controller."
4.	[Set]	Opens the setup window.
5.	Cursor [▲] [▼]	Selects GPIB on the setting window.
6.	[Set]	Closes the setting window and determines the set value.
(Setting the GPIB address)		
7.	Cursor [▲] [▼]	Use these cursor keys to select a GPIB address.
8.	[Set]	Opens the setup window.
9.	[0] [3] [Set]	Set the GPIB address to 03.

3.3 Connection of RS-232C Interface Signal

Connection of RS-232C interface signal between the MT8801C and a personal computer is shown below.

• **Connection to PC98-series personal computer(NEC)**

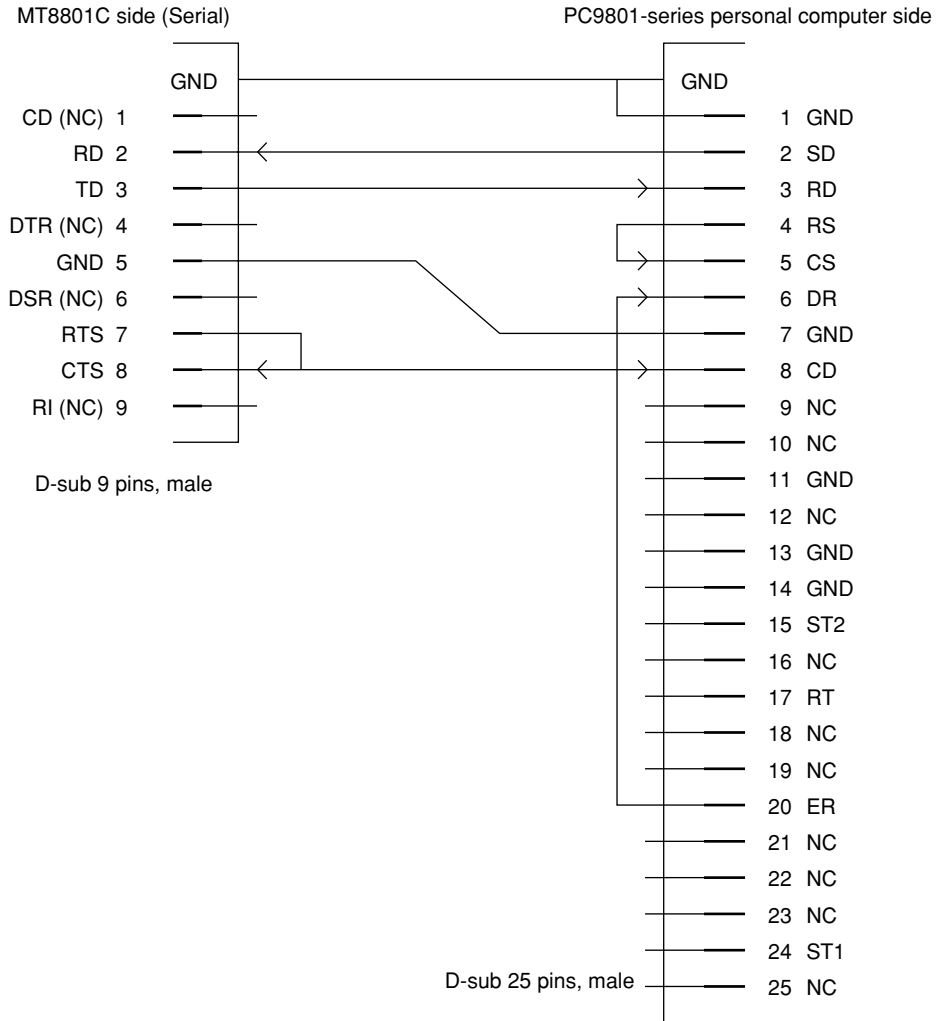

• **Connection to IBM PC/AT personal computer**

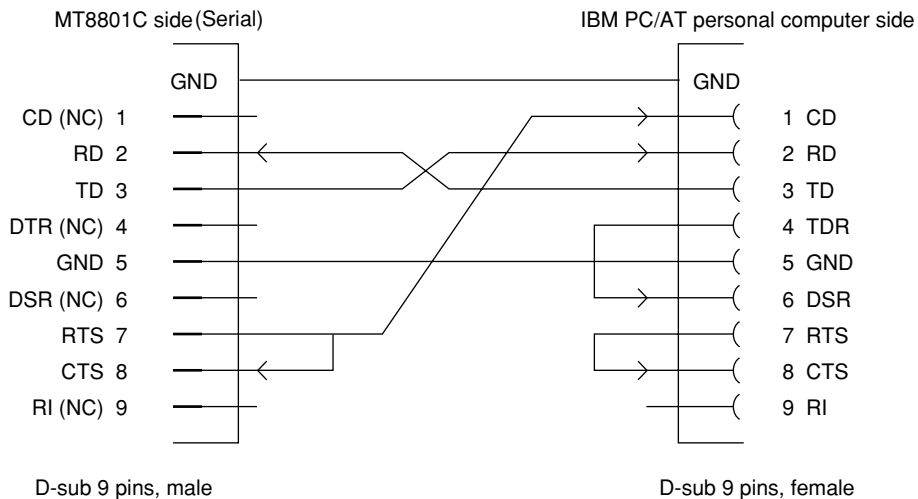

3.4 Setting RS-232C Interface Conditions

Set the RS-232C interface on the Instrument Setup screen at the front panel.
Set the following items:

- | | | | |
|-----|------------|-----------------------|-------------------------|
| (1) | Interface: | Connect to Controller | (Initial value: GPIB) |
| (2) | RS-232C: | Baud Rate | (Initial value: 2400) |
| | | Parity | (Initial value: Even) |
| | | Data Bit | (Initial value: 8 bits) |
| | | Stop Bit | (Initial value: 1 bit) |

Set the RS-232C interface conditions, as described below.

Step	Key operation	Explanation
(Switching to the Instrument Setup screen)		
1.	[Main Func On/Off] F6	Sets the Main Func on to display the main menu.
2.	Next Menu [◀]	Sets the Instrument Setup mode.
	[Instrument Setup] F2	Displays the Instrument Setup screen.
(Selecting the remote control interface)		
3.	Cursor [^] [v]	These cursor keys are used to select "Interface Connect to Controller."
4.	[Set]	Opens the setup window.
5.	Cursor [^] [v]	Selects RS-232C on the setting window.
6.	[Set]	Closes the setting window and establishes the set value.
(Setting the RS-232C interface)		
7.	Cursor [^] [v]	Uses these cursor keys to select the setting item Baud rate.
8.	[Set]	Opens the setup window.
9.	[^] [v] [Set]	Uses these cursor keys to select a Baud rate value (9600 [bps] etc.).
10.	[^] [v]	Sets other interface conditions in the same way.

3.5 Setting the Items Relating to Remote Control and Panel Key Control

3.5.1 Remote control and panel control keys

The keys and lamps described in this paragraph are assigned on the front panel as exclusive keys and lamps.

(1) REMOTE lamp and LOCAL key

The REMOTE lamp indicates that the MT8801C is controlled remotely via the GPIB interface. When the MT8801C is controlled remotely from an external controller via the GPIB interface on the rear panel, the REMOTE lamp lights. While the REMOTE lamp is on, key entry and rotary encoder entry from the front panel are disabled. The LOCAL key is used to cancel the remote control status of the GPIB interface. When the LOCAL key is pressed, the REMOTE lamp goes off and key entry and rotary encoder entry from the front panel are enabled.

(2) PANEL LOCK key

The PANEL LOCK key is used to enable and disable key entry and rotary encoder entry from the front panel. Use the PANEL LOCK key to prevent an operation error on the front panel for automatic measurement or status holding. When the panel is locked, the green lamp on the PANEL LOCK key lights.

3.5.2 Remote control status

If the MT8801C is controlled remotely, the REMOTE lamp on the left of the front panel lights. While the REMOTE lamp is on, key entry and rotary encoder entry from the front panel are disabled. To change from the remote control to front panel entry status, execute the following steps:

- (1) Halt the remote control.
- (2) If the REMOTE lamp is on, press the LOCAL key to cancel the REMOTE status.

Section 4 Device Message Format

This section describes the format of the device messages transmitted between a controller and the MT8801C via the GPIB system.

4.1	General Description	4-2
4.2	Program Message Format	4-3
4.3	Response Message Format	4-7

4.1 General Description

The device messages are data messages that are transmitted between the controller and devices. There are two types of data messages: program messages output from the controller to the MT8801C, and response messages input from the MT8801C by the controller. There are also two types of program commands and program queries in the program message. The program command is used to set this instrument's parameters and to instruct it to execute processing. The program query is used to query the values of parameters and measured results.

4.2 Program Message Format

To transfer program messages from the controller to the MT8801C using the PRINT statement, the program message formats are defined as follows:

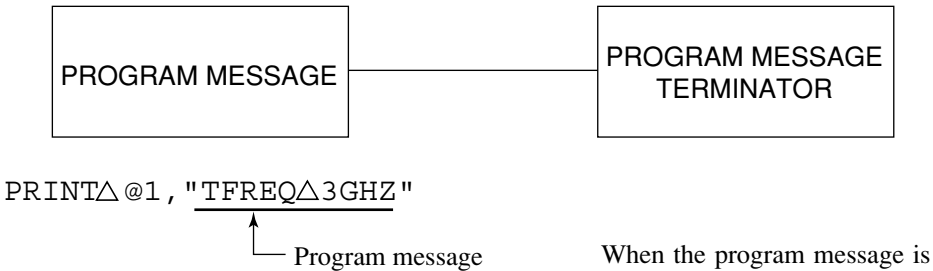

When the program message is transmitted from the controller to the MT8801C, the specified terminator is attached.

(1) PROGRAM MESSAGE TERMINATOR

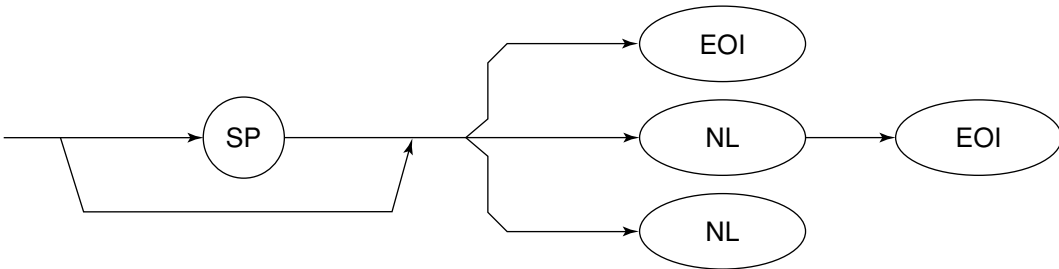

NL : New line or LF (Line Feed)

EOI : The EOI signal of the GPIB interface is used to indicate message termination.

Carriage Return (CR) is ignored, and is not processed as a terminator.

(2) PROGRAM MESSAGE

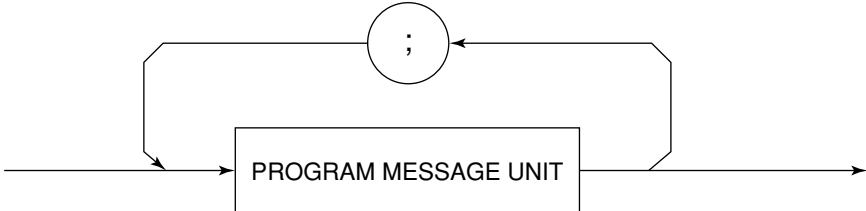

Multiple commands can be output sequentially by concatenating each of them with a semicolon.

<Example> PRINT@1,"TFREQ1GHZ;RFLVLUP"

(3) PROGRAM MESSAGE UNIT

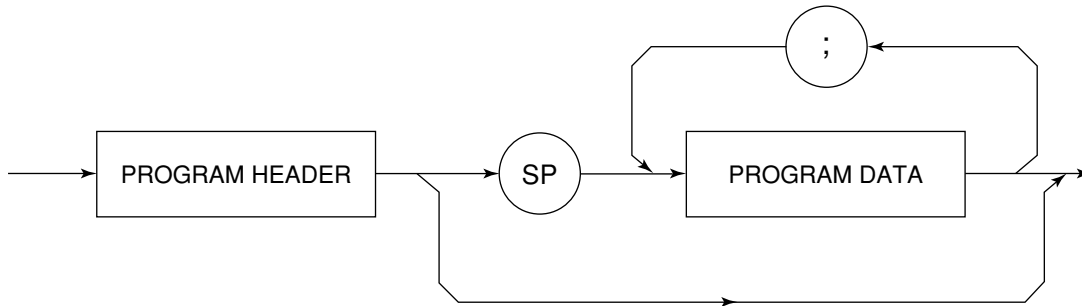

- Each IEEE488.2 common command has a leading asterisk “*” that is always placed before the program header.
- The program query has a trailing question mark “?” that is always added at the end of the program header.

(4) PROGRAM DATA

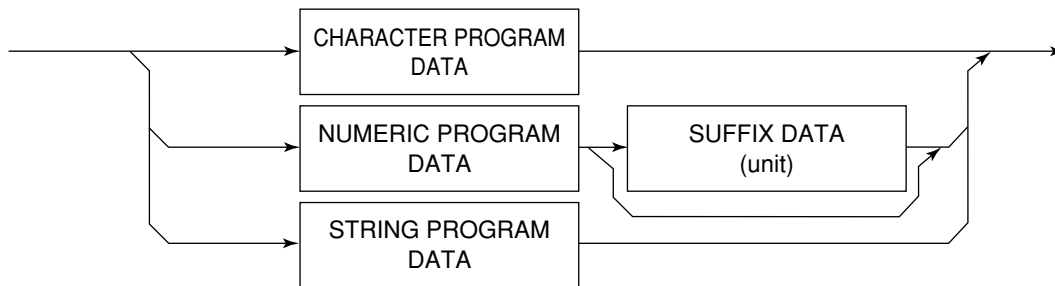

(5) CHARACTER PROGRAM DATA

Character program data consists of uppercase alphabetic characters from A to Z, lowercase alphabetic characters from a to z, the underline “_”, and the numbers 0 to 9. These characters can be used in specified combinations.

<Example> PRINT △ @1, △ ”MKR △ NRM” Sets Marker to Normal.

(6) NUMERIC PROGRAM DATA

Numeric program data has two types of formats: integer format (NR1) and fixed-point real number format (NR2).

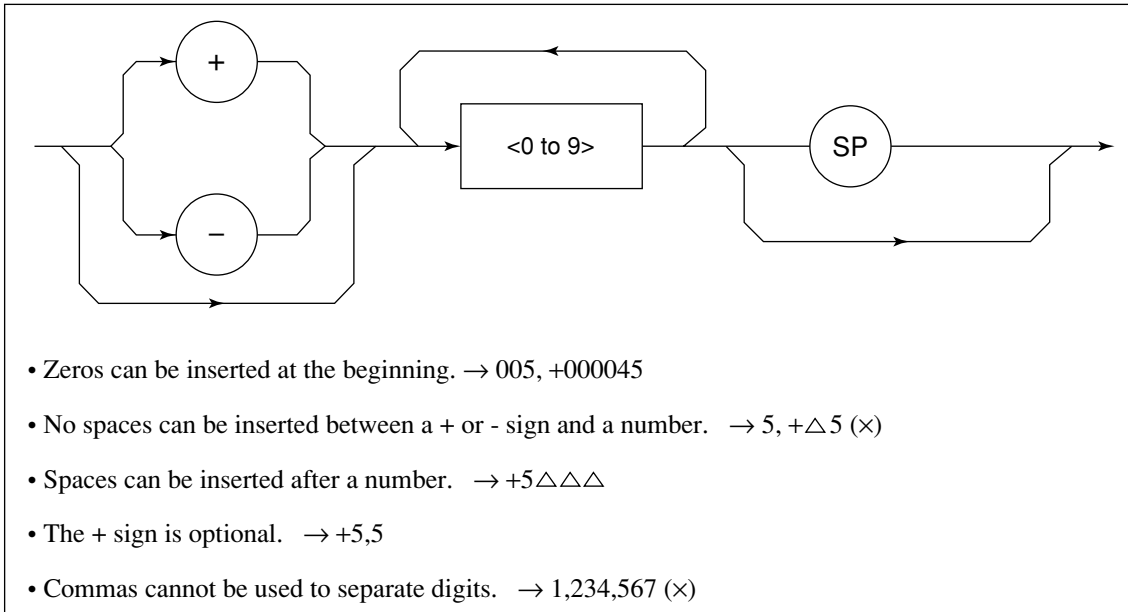
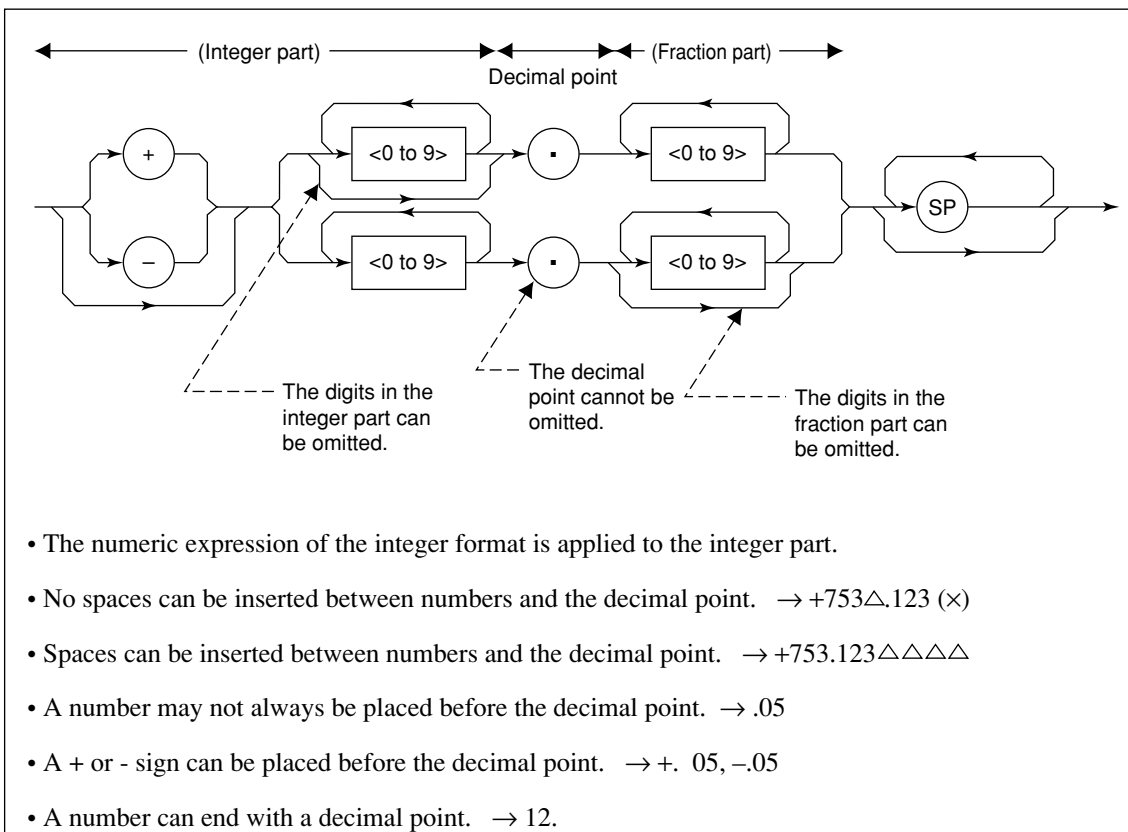
<Integer Format (NR1)>**<Fixed-Point (real number) Format (NR2)>**

(7) STRING PROGRAM DATA

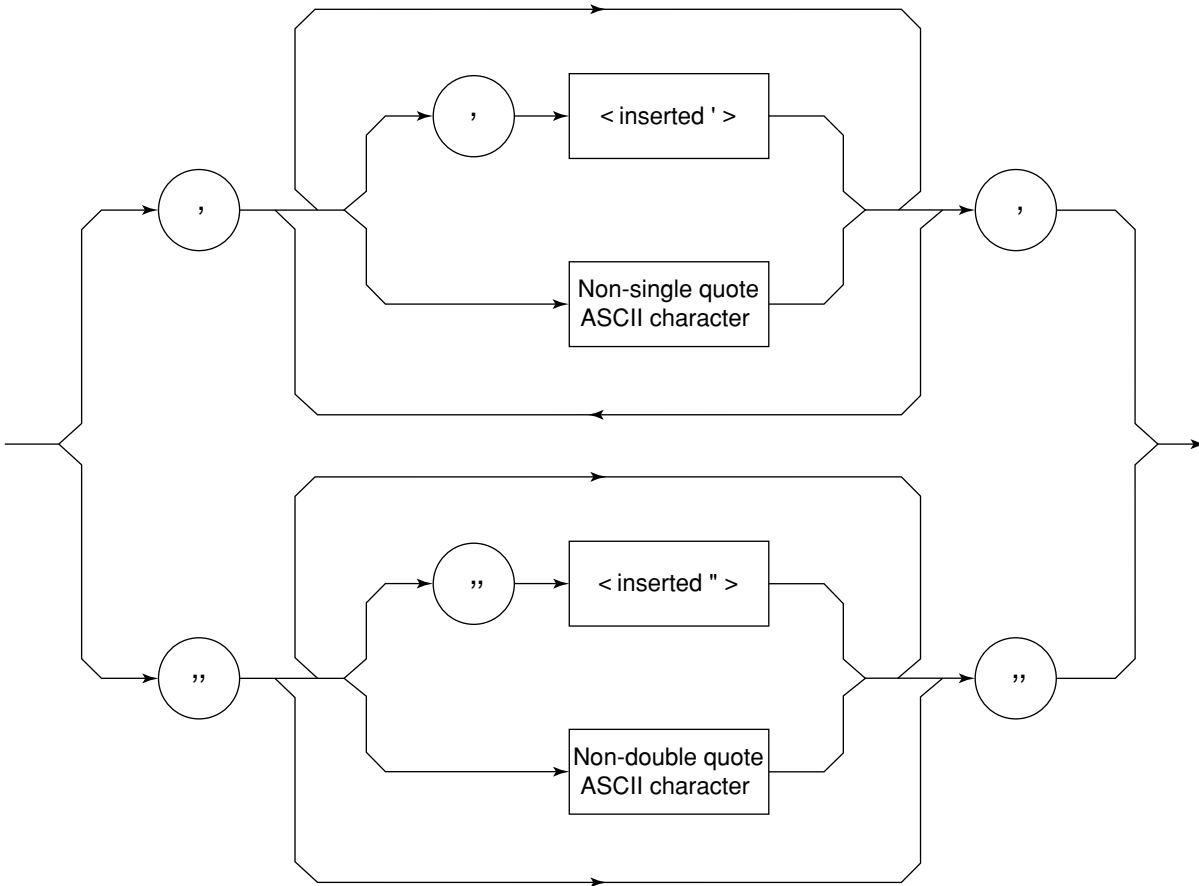

- Both ends of string program data must have a pair of double quotation marks “ ”.

```
PRINT @1,"TITLE 'MT8801C' "
```

A single quotation mark used within the character string must be repeated as shown in ' or “.

```
PRINT @1,"TITLE 'MT8801C' 'NOISE MEAS' ' ' "
```

Executing TITLE results in MT8801C 'NOISE MEAS'.

Note:

To use the double quotation mark “ in the PRINT statement, specify CHR\$ (&H22).

4.3 Response Message Format

To transfer responses messages from the MT8801C to the controller by using the INPUT statement, the response message formats are defined as follows:



(1) RESPONSE MESSAGE TERMINATOR

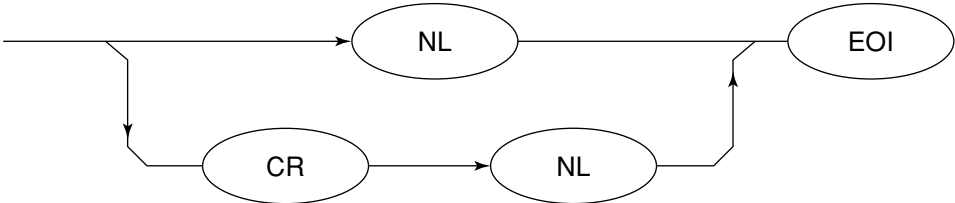

The response message terminator to be used depends on the TRM command.

(2) RESPONSE MESSAGE

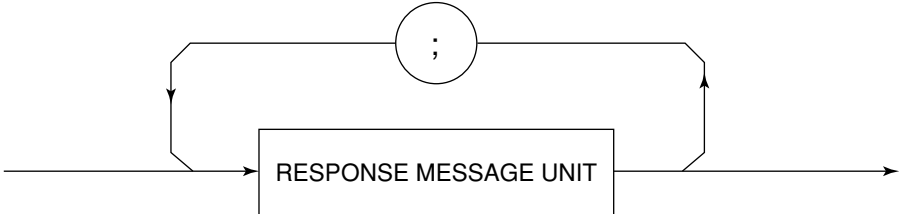

When a query is sent by the PRINT statement with one or more program queries, the response message also consists of one or more response message units.

(3) Normal RESPONSE MESSAGE UNIT

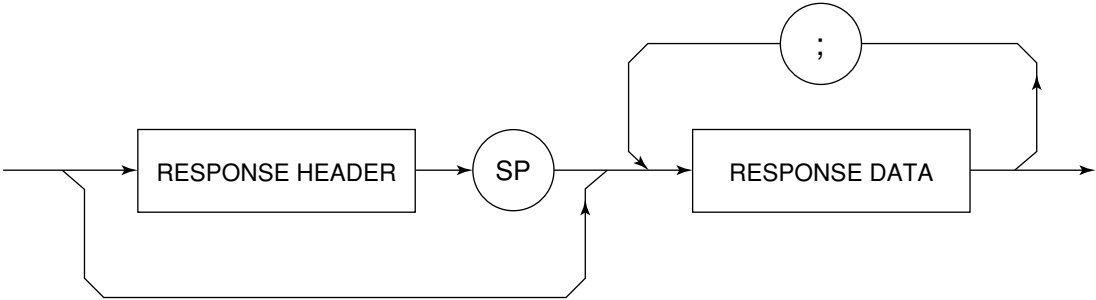

(4) RESPONSE DATA

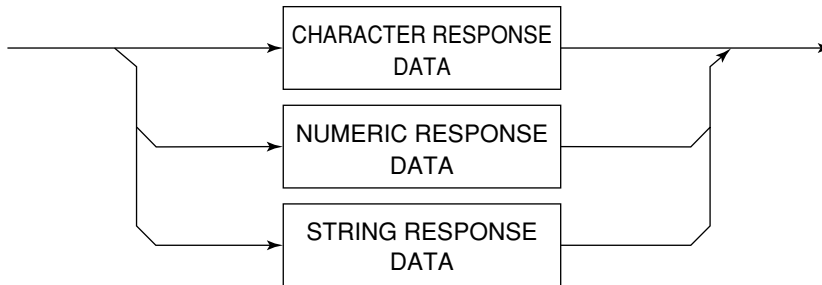

(5) CHARACTER RESPONSE DATA

Character response data consists of uppercase alphabetic characters from A to Z, lowercase alphabetic characters from a to z, the underline “_”, and the numbers 0 to 9. These characters can be used in specified combinations.

(6) NUMERIC RESPONSE DATA

<Integer Format (NR1)>

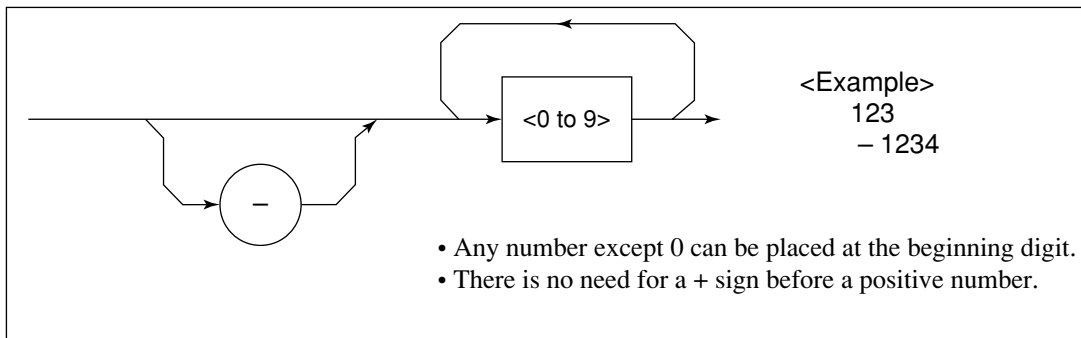

<Integer Format (NR1)>

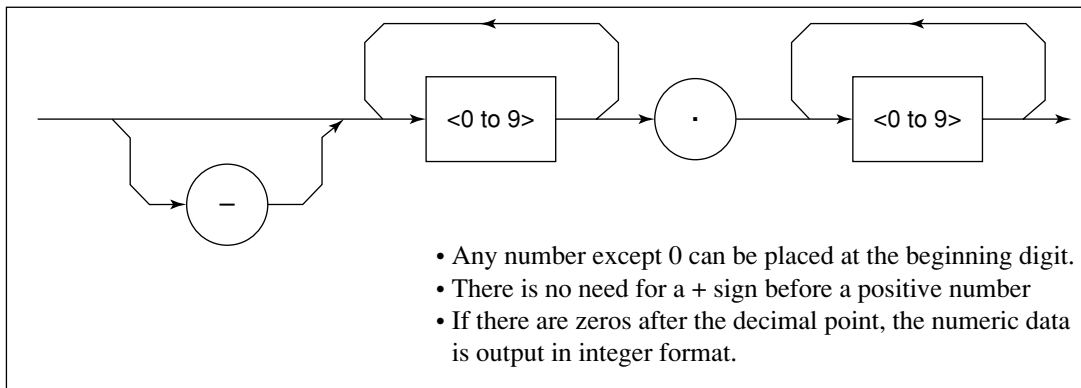

(7) STRING RESPONSE DATA

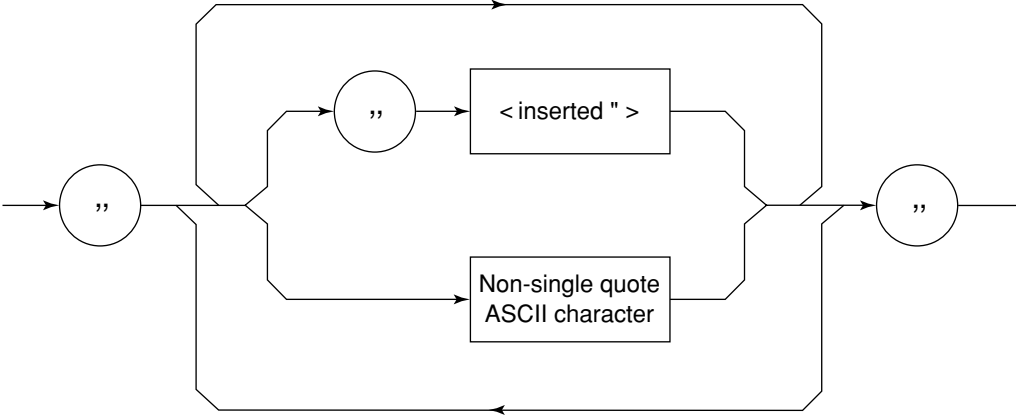

String response data is output as an ASCII character string, which is enclosed with double quotation marks.

Section 4 Device Message Format

Section 5 Status Messages

This section describes MT8801C status messages, their data structure and models, and explains the techniques for synchronizing the controller and the MT8801C.

To obtain more detailed status information, the IEEE488.2 standard has more common commands and common queries than the IEEE488.1 standard.

The Status Byte (STB) sent to the controller is based on the IEEE488.1 standard. The bits comprising it are called a status summary message because they represent a summary of the current data contained in registers and queues.

The following pages explain the status summary message and structure of status data that constitutes the status summary message bits, as well as techniques for synchronizing the MT8801C and controller, which use these status messages.

These functions are used by an external controller with the GPIB interface bus.

Almost functions can be used by an external controller with the RS-232C interface.

5.1	IEEE488.2 Standard Status Model	5-2
5.2	Status Byte (STB) Register	5-4
5.2.1	ESB and MAV summary messages	5-4
5.2.2	Device-dependent summary messages	5-5
5.2.3	Reading and clearing the STB register	5-6
5.3	Enabling the Service Request (SRQ)	5-8
5.4	Standard Event Status Register	5-9
5.4.1	Bit definition of standard event status register	5-9
5.4.2	Query error details	5-10
5.4.3	Reading, writing to and clearing the standard event status register	5-11
5.4.4	Reading, writing to and clearing the standard event status enable register	5-11
5.5	Extended Event Status Register	5-12
5.5.1	Bit definition of END event status register	5-13
5.5.2	Bit definition of ERR event status register	5-14
5.5.3	Reading, writing to and clearing the extended event status register	5-15
5.5.4	Reading, writing to and clearing the extended event status enable register	5-15
5.6	Techniques for Synchronizing the MT8801C with a Controller	5-16
5.6.1	Wait for SWP or TS command termination ...	5-16
5.6.2	Wait for response after *OPC? query is sent ...	5-17
5.6.3	Wait for service request after *OPC is sent ..	5-18
5.6.4	Wait for status generation of the status register ...	5-19
5.6.5	Wait for service request issuance from the status register	5-20

5.1 IEEE488.2 Standard Status Model

The diagram below shows the standard model for the status data structure stipulated in the IEEE488.2 standard.

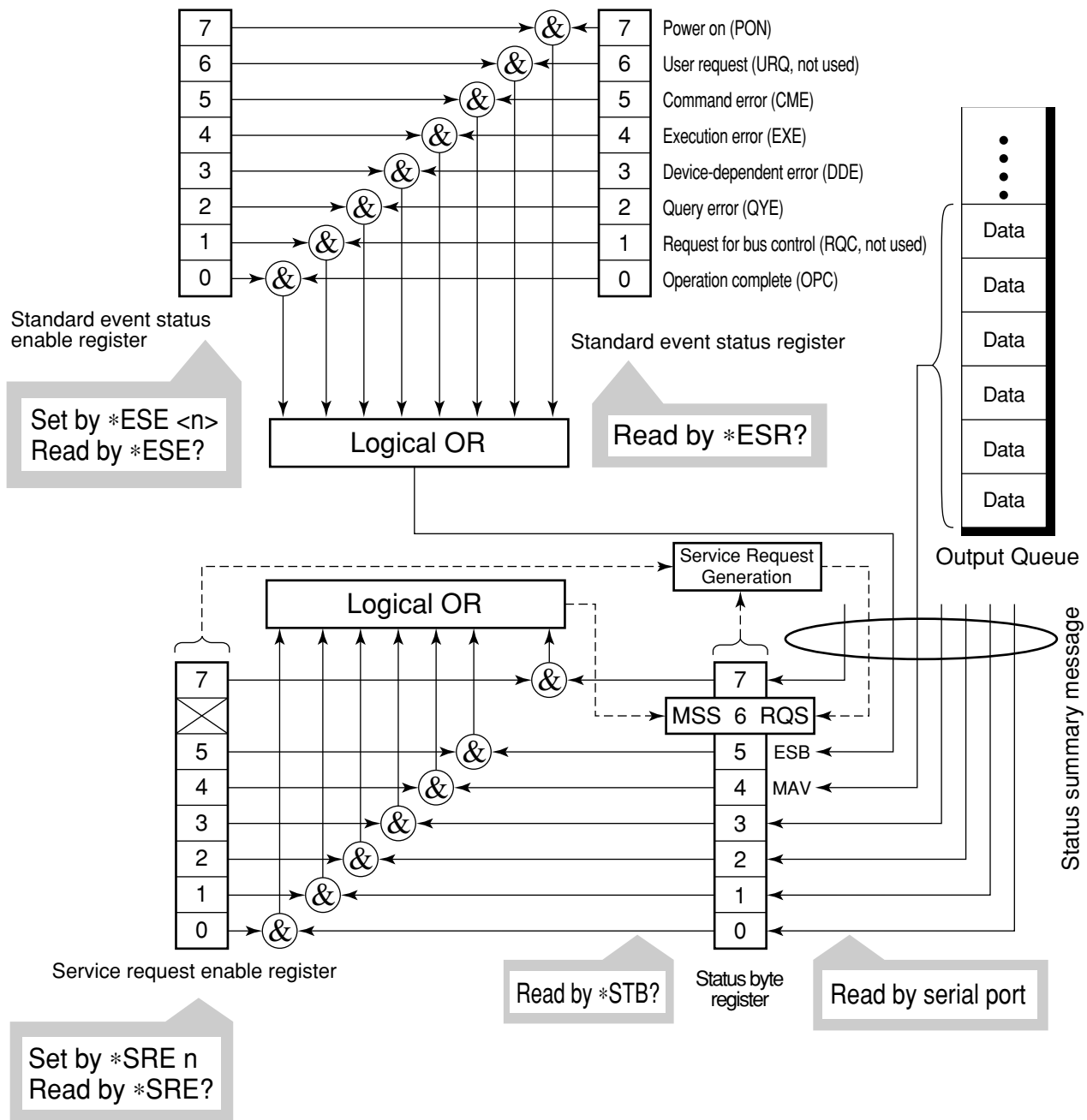

Standard Status Model Diagram

5.1 IEEE488.2 Standard Status Model

The IEEE488.1 status byte is used in the status model. This status byte is composed of seven summary message bits given from the status data structure. To create the summary message bits, there are two models for the data structure: the register model and the queue model.

Register model	Queue model
The register model consists of the two registers used for recording events and conditions encountered by a device. These two registers are the Event Status Register and Event Status Enable Register. When the result of the AND operation of both register contents is not 0, the corresponding bit of the status bit becomes 1. In other cases, it becomes 0. And, when the result of their Logical OR is 1, the summary message bit also becomes 1. If the logical OR result is 0, the summary message bit also becomes 0.	The queue in the queue model is for sequentially recording the waiting status values and data. The queue structure is such that the relevant bit is set to 1 when there is data in it and 0 when it is empty.

In IEEE488.2, there are three standard models for status data structure, two register models and one queue model, based on the register model and queue model explained above. They are:

- [1] Standard Event Status Register and Standard Event Status Enable Register
- [2] Status Byte Register and Service Request Enable Register
- [3] Output Queue

Standard Event Status Register	Status Byte Register	Output Queue
The Standard Event Status Register has the structure of the previously described register model. In this register, bits are set for eight types of standard events encountered by a device. [1] Power on, [2] User request, [3] Command error, [4] Execution error, [5] Device-dependent error, [6] Query error, [7] Request for bus control and [8] Operation complete. The logical OR output bit is represented by Status Byte Register bit 5 (DIO6) as a summary message for the Event Status Bit (ESB).	The Status Byte Register is a register in which the RQS bit and the seven summary message bits from the status data structure can be set. It is used together with the Service Request Enable Register. When the result of the OR operation of both register contents is not 0, SRQ goes ON. To indicate this, bit 6 of the Status Byte Register (DIO7) is reserved by the system as the RQS bit, which indicates a service request for the external controller. The mechanism of SRQ conforms to the IEEE488.1 standard.	The Output Queue has the structure of the queue model mentioned above. Status Byte Register bit 4 (DIO5) is set as a summary message for Message Available (MAV) to indicate that there is data in the output buffer.

5.2 Status Byte (STB) Register

The STB register consists of device STB and RQS (or MSS) messages. The IEEE488.1 standard defines the method of reporting STB and RQS messages, but not the setting and clearing of protocols or the meaning of STB. The IEEE488.2 standard defines the device status summary message and the Master Summary Status (MSS) which is sent to bit 6 together with STB in response to an *STB? common query.

5.2.1 ESB and MAV summary messages

The following describes the ESB and MAV summary messages.

(1) ESB summary messages

The ESB (Event Summary Bit) summary message is a message defined by IEEE488.2, and is represented by bit 5 of the STB register. This bit indicates whether at least one of the events defined in IEEE488.2 has occurred when the service request enable register is set to enable events after the final reading or clearing of the standard event register.

The ESB summary message bit becomes 1 when the setting permits events to occur if any of the events recorded in the standard event status register becomes 1. The ESB summary bit becomes true when the setting permits events to occur if any of the events registered in the standard event status register is true. Conversely, it is false if none of the recorded events occurs even if events are set to occur.

This bit becomes FALSE (0) when the ESR register is read by the *ESR? query and the ESR register is cleared by the *CLS command.

(2) MAV summary messages

The MAV summary message is a message defined in IEEE488.2 and represented by bit 4 in the STB register. This bit indicates whether the output queue is empty. The MAV summary message bit is set to 1 (true) when a device is ready to receive a request for a response message from the controller and to 0 (false) when the output queue is empty. This message is used to synchronize the exchange of information with the controller. For example, this message can be used to make the controller wait until MAV is true after it sends a query command to the device. While the controller is waiting for a response from the device, it can process other jobs. Reading the output queue without first checking MAV delay all system bus operations until the device responds.

5.2.2 Device-dependent summary messages

The IEEE488.2 standard specifies that bits 7 (DIO8) and 3 (DIO4) to 0 (DIO1) of the status byte register can be used as status register summary bits, or to indicate that there is data in a queue.

Device-dependent summary messages have the respective status data structures of the register model or the queue model. Thus, the status data structure may be either the register to report events and status in parallel or the queue to report conditions and status in sequence. The summary bit represents a summary of the current status of the corresponding status data structure. For the register model, the summary message is true when there is an event set to permit the occurrence of more than one true event; while for the queue model, it is true if the queue is not empty.

As shown below, the MT8801C does not use bits 0, 1 and 7. As it uses bits 2 and 3 as the summary bit of the status register, it has 3 register model types (where 2 types are extended) and one queue model type (with no extension).

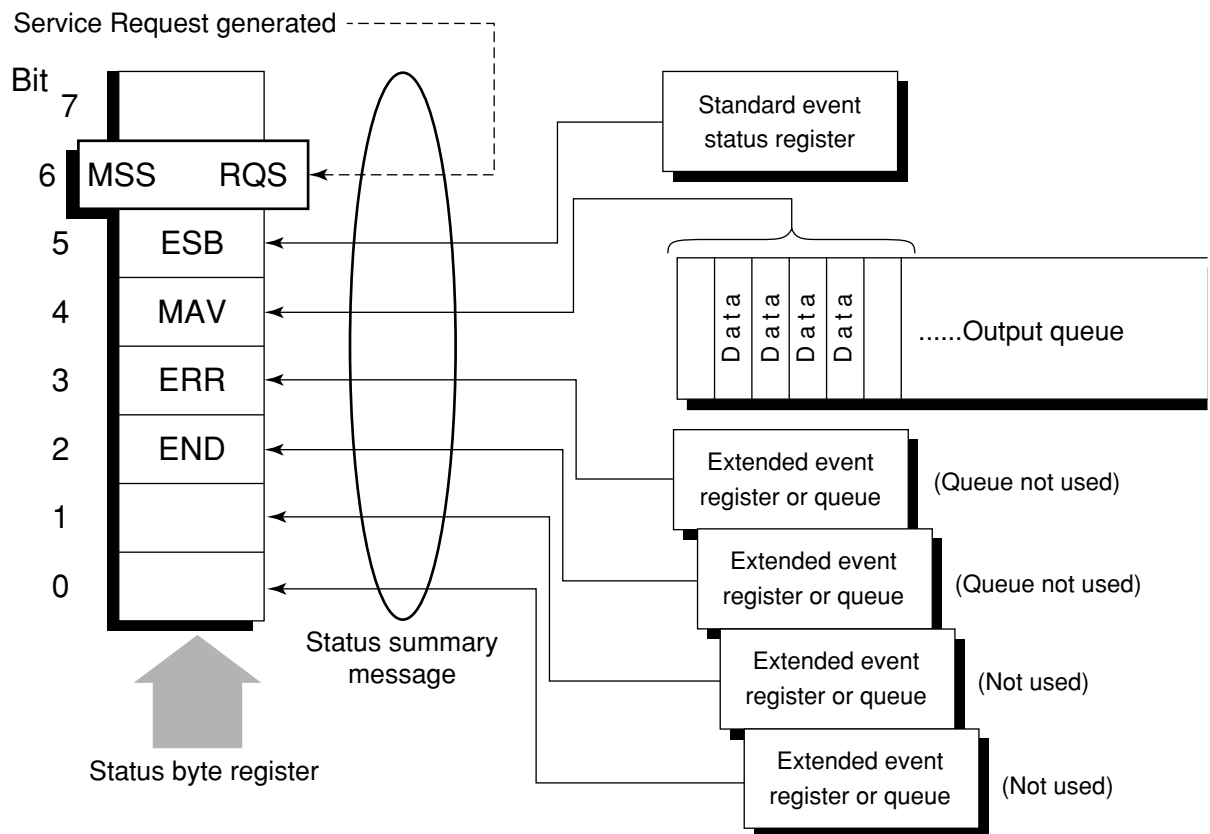

5.2.3 Reading and clearing the STB register

Serial poll or the *STB? common query are used to read the contents of the STB register. STB messages conforming to IEEE488.1 can be read by either method, but the value sent to bit 6 (position) is different for each message.

The STB register can be cleared by using the *CLS command.

(1) Reading by serial poll (only when using the GPIB interface)

When using serial poll conforming to IEEE488.1, the device must return a 7 bit status byte and an RQS message bit which conforms to IEEE488.1. According to IEEE488.1, the RQS message indicates whether the device sent SRQ as true or not. The value of the status byte is not changed by serial poll. The device must set the RQS message to false immediately after being polled. As a result, if the device is again polled before there is a new cause for a service request, the RQS message is false.

(2) Reading by the *STB common query

The *STB? common query requires the device to send the contents of the STB register and an integer format response message from the MSS (Master Summary Status) summary message. The response represents the total binary weighted value of the STB register and the MSS summary message. STB register bits 0 to 5 and 7 are weighted to 1, 2, 4, 8, 16, 32, and 128; and the MSS to 64, respectively. Thus, excepting the fact that bit 6 represents the MSS summary message instead of the RQS message, the response to *STB? is identical to that for serial poll.

(3) Definition of MSS (Master Summary Status)

MSS indicates that there is at least one cause for a service request. The MSS message is represented by bit 6 in a device response to the *STB? query, but it is not generated response to serial poll. In addition, it is not part of the status byte specified by IEEE488.1. MSS is generated by the logical OR operation of the STB register with SRQ enable (SRE) register. In concrete terms, MSS is defined as follows:

$$\begin{aligned} &(\text{STB Register bit0 AND SRE Register bit0}) \\ &\quad \text{OR} \\ &(\text{STB Register bit1 AND SRE Register bit1}) \\ &\quad \text{OR} \\ &\quad \text{:} \\ &\quad \text{:} \\ &(\text{STB Register bit5 AND SRE Register bit5}) \\ &\quad \text{OR} \\ &(\text{STB Register bit7 AND SRE Register bit7}) \end{aligned}$$

Since bit-6 status of the STB and SR enable registers is ignored in the definition of MSS, it can be considered that bit-6 status is always being 0 when calculating the value of MSS.

(4) Clearing the STB register by the *CLS common command

With the exception of the output queue and its MAV summary message, the *CLS common command clears all status data structures (status event registers and queues) as well as the corresponding summary messages.

The *CLS command does not affect settings in the enable registers.

5.3 Enabling the Service Request (SRQ)

All types of summary messages in the STB register can be enabled or disabled for service requests (SRE) by using the program-controlling service request (SRQ) enable operation. The service request enable (SRE) register controls the generation of SRQ in bits 0 to 7 as shown in the diagram below.

Bits in the service request enable register correspond to bits in the status byte register. If a bit in the status byte corresponding to an enabled bit in the service request enable register is set to 1, the device makes a service request to the controller with the RQS bit set to 1. For example, if bit 4 in the service request enable register is enabled, the device makes a request for service to the controller each time the MAV bit is set to 1 when there is data in the output queue.

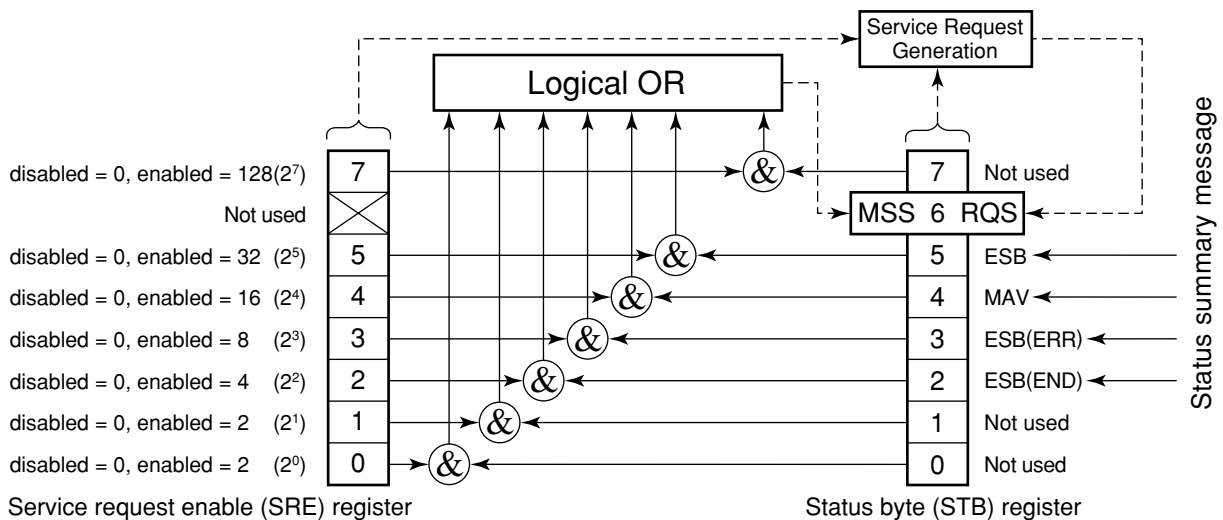

(1) Reading the SRE register

The contents of the SRE register are read using the *SRE? common query. The response message to this query is an integer from 0 to 255, which is the sum of the bit digit weighted values in the SRE register. SRE register bits 0 to 5 and 7 are respectively weighted to 1, 2, 4, 8, 16, 32, and 128. The unused bit 6 must always be set to 0.

(2) Updating the SRE register

The *SRE common instruction is used to write data to the SRE register. An integer from 0 to 255 is added after the *SRE. fm3common instruction.

This integer indicates the total number of bits in the SRE register (weighted values: 1, 2, 4, 8, 16, 32, and 128), and sets the corresponding SRE register bit to 0 or 1.

A bit value of 1 indicates an enabled state; 0 indicates a disabled state. Always ignore the value of bit 6.

5.4 Standard Event Status Register

5.4.1 Bit definition of standard event status register

The standard event status register must be available on all devices conforming to the IEEE488.2 standard. The diagram below shows the operation of the standard event status register model. Because the operation of the model is the same as that for the other models already described, the following only explains the meaning of each bit in the standard event status register as defined in the IEEE488.2 standard.

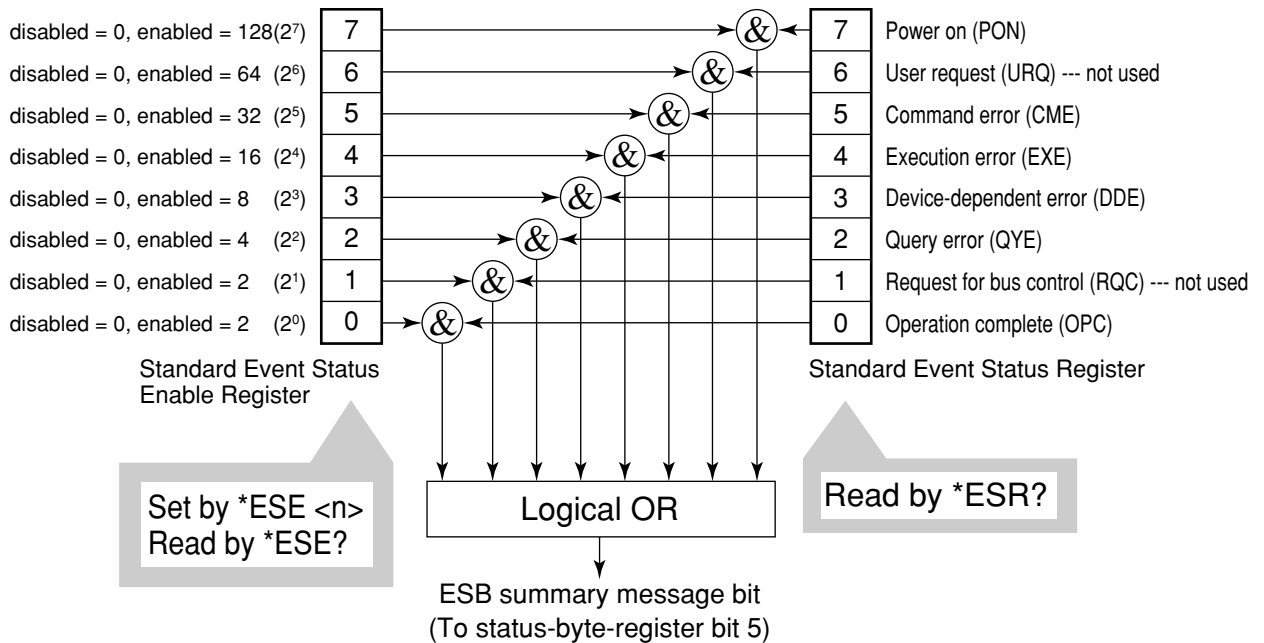

Standard event status enable (ESE) register selects whether the register makes the summary message true when the corresponding bit of the event status register is set.

Bit	Event name	Description
7	Power on (PON)	The power is turned on.
6	User Request (URQ)	Request for local control (rtl). This bit is produced regardless of whether a device is in remote or local mode. It is not used for the MT8801C so, it is always set to 0.
5	Command Error (CME)	An illegal program message, a misspelt command or a GET command within a program is received.
4	Execution error (EXE)	A legal program message, which cannot be executed, is received.
3	Device-dependent Error (DDE)	An error caused by other than CME, EXE or QYE (e.g., parameter error) occurred.
2	Query Error (QYE)	An attempt is made to read data in the output queue though there is none there, or data is lost from the output queue due to some reason (e.g., overflow).
1	Request Control (RQC)	A device is requesting an active controller. This bit is not used for the MT8801C so, it is always set to 0.
0	Operation Complete (OPC)	A device has completed specified operations and is ready to receive new commands. This bit is only set in response to the *OPC command.

Section 5 Status Messages

5.4.2 Query error details

No.	Item	Description
1	Incomplete program message	If a device receives an MTA from the controller before it receives the terminator of the program message it is receiving, it aborts the incomplete program message and waits for the next one. To abort the incomplete message, the device clears its input-output buffer, reports a query error to the status report section and sets bit 2 in the standard status register to indicate the query error.
2	Interruption of response message output	If a device receives an MLA from the controller before it has sent the terminator of the response message it is sending, it automatically interrupts response message output and waits for the next program. To interrupt the response message output, the device clears its output buffer, reports a query error to the status report section, and sets bit 2 in the standard status register to indicate the query error.
3	Sending the next program message without reading the previous response message	When a device becomes unable to send a response message because the controller has sent another program message immediately following a program or query message, the device aborts the response message and waits for the next program message. It then reports a query error to the status report section as in No.2 above.
4	Output queue overflow	When several program and query messages are executed in succession, too many response messages for the output queue (256 bytes) may be generated. If further query messages are received when the output queue is full, the output queue cannot send corresponding responses due to the overflow situation. If there is overflow in the output queue, the device clears it and resets the section where response messages are created. Then it sets bit 2 in the standard event status register to indicate a query error.

5.4.3 Reading, writing to and clearing the standard event status register

Reading	<p>The register is read by the *ESR? common query.</p> <p>The register is cleared after being read. The response message is an integer format data value obtained by binary weighting the event bit and converting it to a decimal number.</p>
Writing	<p>With the exception of clearing, writing operations cannot be performed externally.</p>
Clearing	<p>The register is only cleared in the following cases:</p> <p>[1] A *CLS command received.</p> <p>[2] The power is turned on.</p> <p>Devices first clear their standard event status registers but later record events that occurred during the sequence in the registers (e.g., setting of the PON event bit).</p> <p>[3] An event is read for the *ESR? command.</p>

5.4.4 Reading, writing to and clearing the standard event status enable register

Reading	<p>The register is read by the *ESE? common query.</p> <p>The response message is an integer format data value obtained by binary weighting the event bit and converting to a decimal number.</p>
Writing	<p>The register is written to by the *ESE common command. As bits 0 to 7 of the register are respectively weighted to 1, 2, 4, 8, 16, 32, 64, and 128, data to be written is sent by <DECIMAL NUMERIC PROGRAM DATA> which is the digit total of the bits selected from these bits.</p>
Clearing	<p>The register is cleared in the following cases:</p> <p>[1] An *ESE command with a data value of 0 is received.</p> <p>[2] The power is turned on.</p> <p>The standard event status enable register is not affected by the following:</p> <p>[1] Changes of the status of the IEEE488.1 device clear function</p> <p>[2] An *RST common command is received.</p> <p>[3] A *CLS common command is received.</p>

5.5 Extended Event Status Register

The register models of the status byte register, standard event status register and enable registers are mandatory for equipment conforming to the IEEE488.2 standard. In IEEE488.2, status-byte-register bits 7 (DIO8), 3 (DIO4) to 0 (DIO1) are assigned to status summary bits supplied by the extended-register and extended-queue models. For the MT8801C, as shown in the diagram below, bits 7, 1 and 0 are unused; bits 2 and 3 are assigned to the END and ERR summary bits as the status-summary bits supplied by the extended-register model. As the queue model is not extended, there is only one type of queue: the output queue.

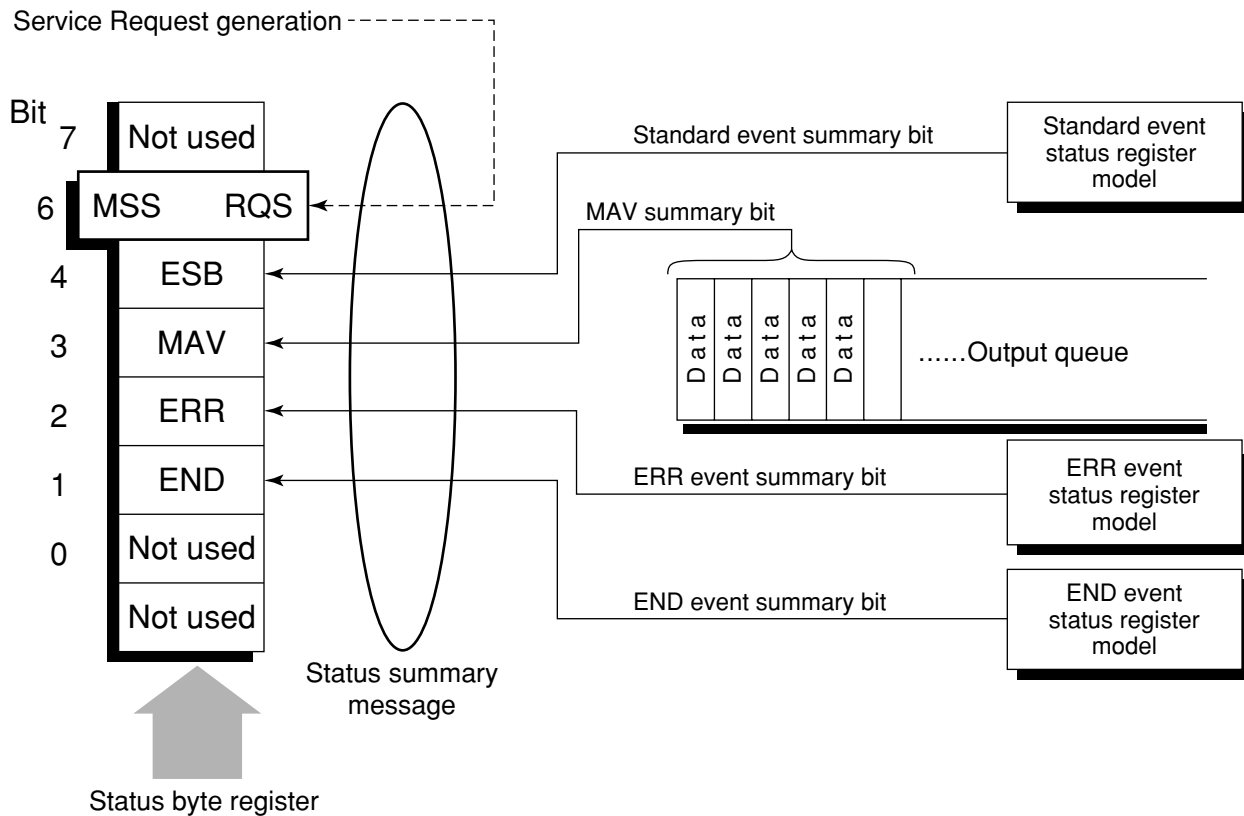

The following pages describe bit definition, the reading, writing to and clearing of bits for the END extended event register model.

5.5.1 Bit definition of END event status register

The following describes the operation of the END event status register model, the naming of its event bits, and what they mean.

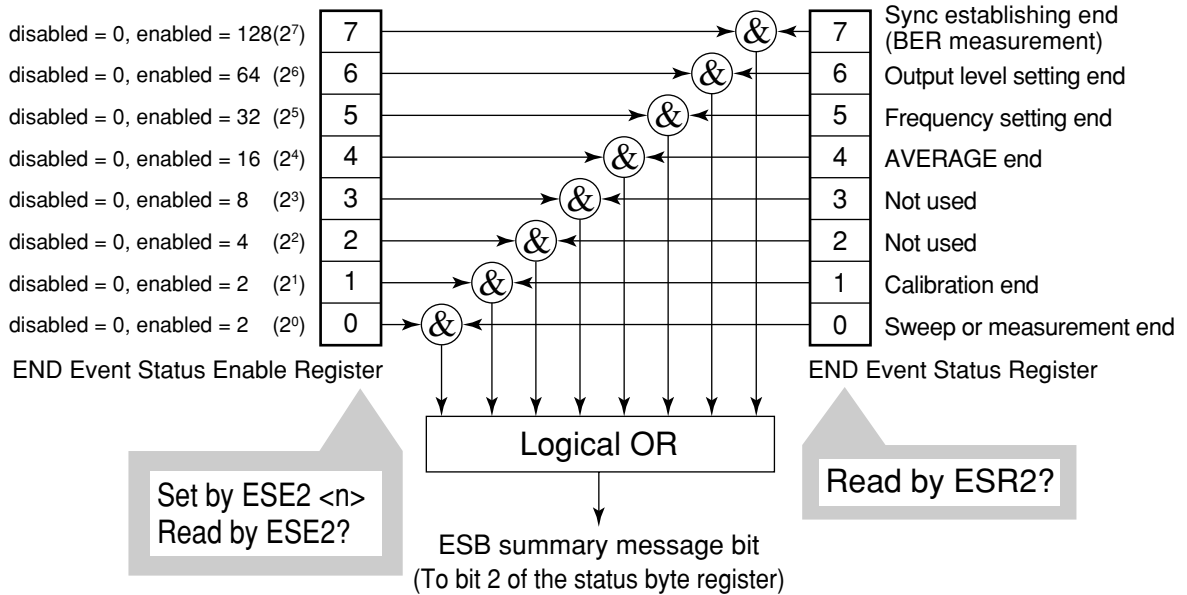

The END event status register selects whether the register makes the summary message true when the corresponding bit of the status register is set.

Bit	Event name	Description
7	Sync establishing end	This bit is set to 1 when synchronization is established after BER measurement starts.
6	Output level setting end	This bit is set to 1 when output level setting ends.
5	Frequency setting end	This bit is set to 1 when frequency setting ends.
4	AVERAGE end	This bit is set to 1 when averaging ends.
3	(Not used)	(Not used)
2	(Not used)	(Not used)
1	CAL end	This bit is set to 1 when calibration ends.
0	Sweep or measurement end	This bit is set to 1 when sweep or measurement ends.

5.5.2 Bit definition of ERR event status register

The following describes the operation of the ERR event status register model, the naming of its event bits, and what they mean.

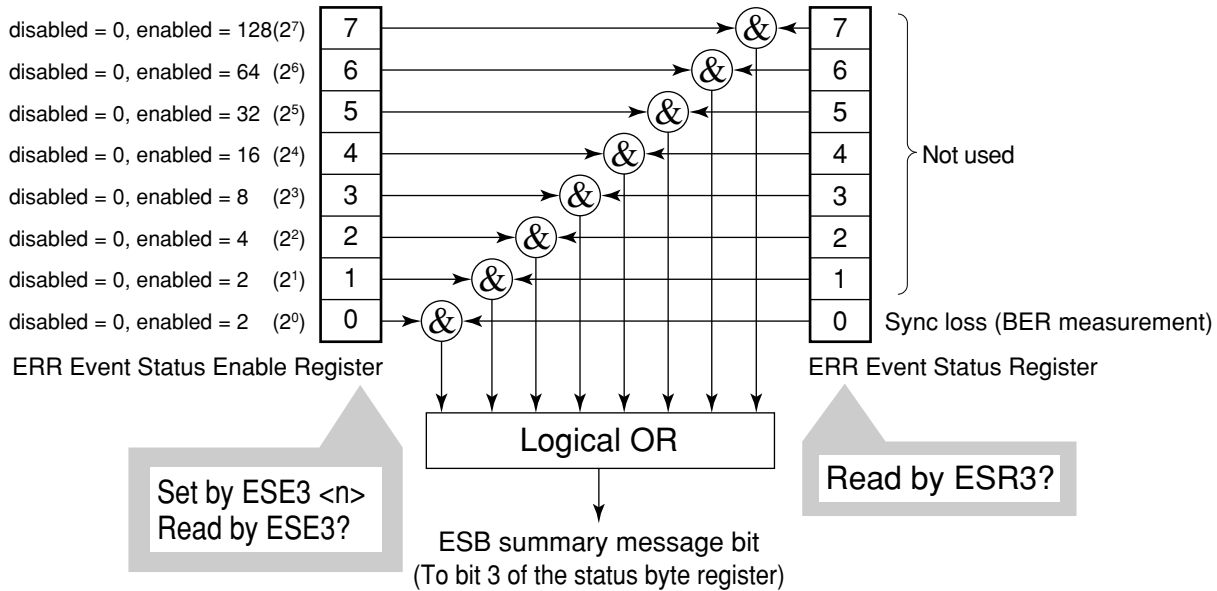

The ERR event status register selects whether the register makes the summary message true when the corresponding bit of the status register is set.

Bit	Event name	Description
7	(Not used)	(Not used)
6	(Not used)	(Not used)
5	(Not used)	(Not used)
4	(Not used)	(Not used)
3	(Not used)	(Not used)
2	(Not used)	(Not used)
1	(Not used)	(Not used)
0	Sync loss	This bit is set to 1 when synchronization loss is occurred.

5.5.3 Reading, writing to and clearing the extended event status register

Reading	The register is destructively read by a query (e.g., it cleared after being read). The END/ERR event status register is read by ESR2?/ESR3? query. The read value, an integer format data (NR1), is obtained by binary weighting the event bit and converting it to decimal.
Writing	With the exception of clearing, writing operations cannot be performed externally.
Clearing	The register is cleared in the following cases: [1] A *CLS command is received. [2] The power is turned on. [3] An event is read by the ESR2?/ESR3? query command.

5.5.4 Reading, writing to and clearing the extended event status enable register

Reading	The register is non-destructively read by a query (i.e., not cleared after being read). The END/ERR event status register is read by the ESE2?/ESE3? query. The read value, an integer format data (NR2), is obtained by binary total weighting the event bit and converting it to decimal.
Writing	The END/ERR event status register is written to by the ESE2/ESE3 program command. As bits 0 to 7 of the registers are respectively binary weighted to 1, 2, 4, 8, 16, 32, 64, and 128, write data is sent as the integer format data obtained by total weighting the digit value of bits selected from among them.
Clearing	The register is cleared in the following cases: [1] The ESE2/ESE3 program command with a data value of 0 is received for the END/ERR event status register. [2] The power is turned on the power-on-status-clear flag is true. The extended event status enable register is not affected by the following: [3] Changes of the status of the IEEE488.1 device clear function [4] An *RST common command is received. [5] A *CLS common command is received.

5.6 Techniques for Synchronizing the MT8801C with a Controller

The MT8801C usually treats program messages as sequential commands that do not execute the processing of newly received commands until the previous command has been processed. Thus, special consideration need not be taken for pair-synchronization between the MT8801C and the controller.

If the controller controls one or more devices and synchronizes with them, after all the commands specified for the MT8801C have been processed, the next commands must be sent to other devices.

There are five ways of synchronizing the MT8801C with the controller:

- [1] Wait for SWP or TS command termination.
- [2] Wait for a response after the *OPC? query is sent.
- [3] Wait for SRQ after *OPC is sent.
- [4] Wait for status generation of the status register.
- [5] Wait for SRQ by the status register.

5.6.1 Wait for SWP or TS command termination

When the MT8801C starts measurement using the SWP or TS command, it stops accepting the next measurement command until it terminates the measurement. Use this feature to set a synchronization.

Note:

A response may not be returned if there is no measurement termination condition (permanent measurement of BER, etc.). In Average measurement mode, a response may be returned before averaging.

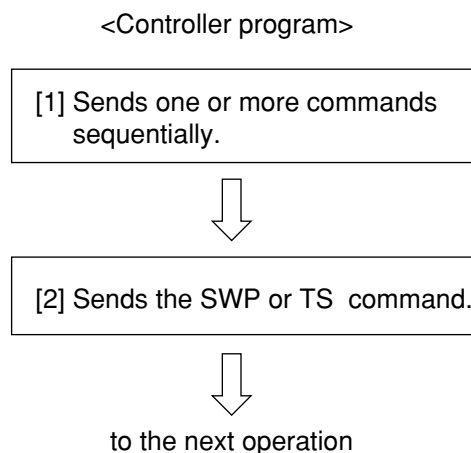

5.6.2 Wait for response after *OPC? query is sent

When executing the *OPC? query command, the MT8801C outputs “1” as the response message at the end of the previous command. The controller is synchronized with the MT8801C by waiting for the request message to be entered.

Note:

When the read response message is “Q” (command is being executed), wait for about 50 ms until the controller moves to the next operation.

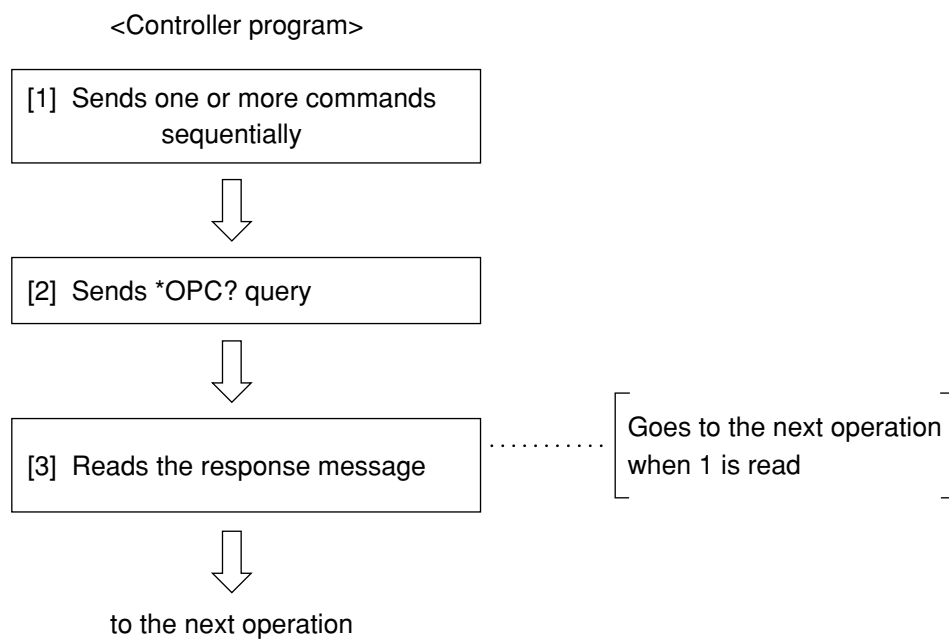

5.6.3 Wait for service request after *OPC is sent

The MT8801C sets the operation-complete bit (bit 0) to 1 when executing the *OPC command. The controller is synchronized with the MT8801C by waiting for SRQ when the operation-complete bit is set for SRQ.

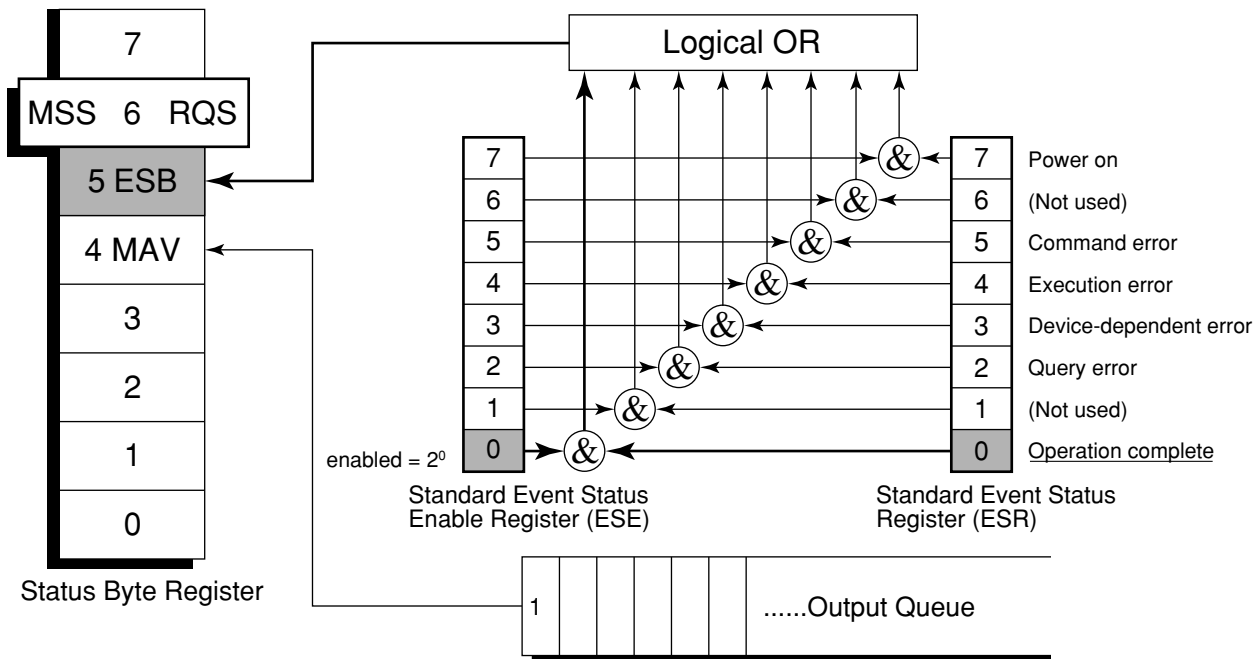

■ <Controller program>

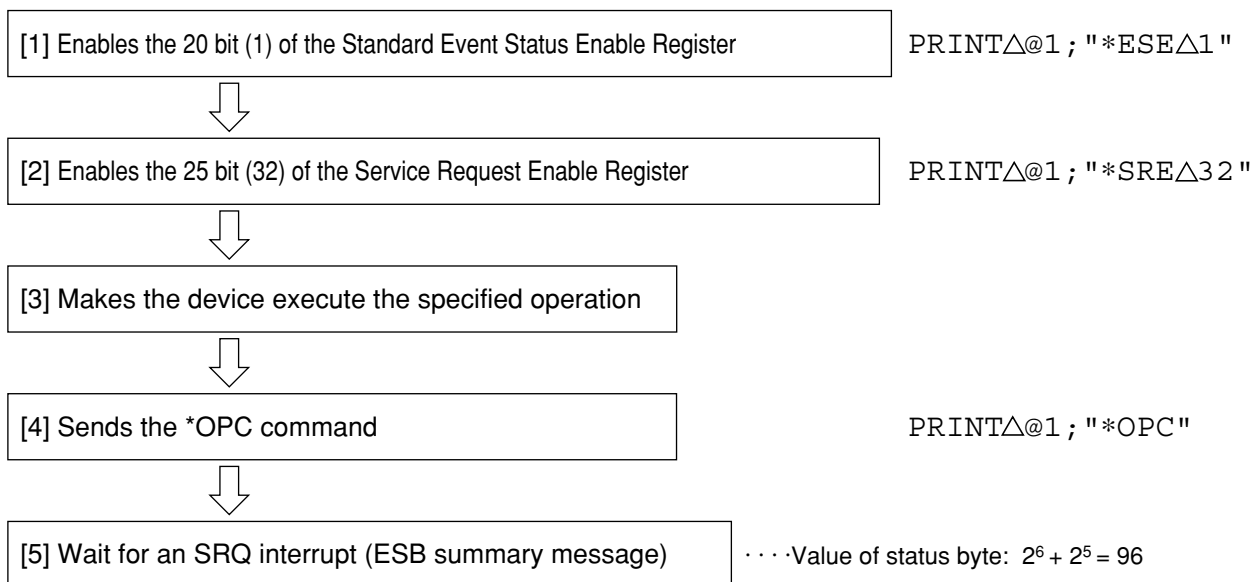

5.6.4 Wait for status generation of the status register

An event status register bit of the MT8801C is set to 1 when the corresponding event occurs. When the *ESR?, ESR2?, or ESR3? query is executed, the MT8801C outputs the value of the corresponding status register as a response message. The controller reads this response message and waits until the response becomes the specified value for synchronization. Reset the event status register immediately before making a desired event occur.

Note:

Wait for 50 ms for the controller to go to the next operation after reading a response message.

• <Controller program : Synchronization by operation termination bit>

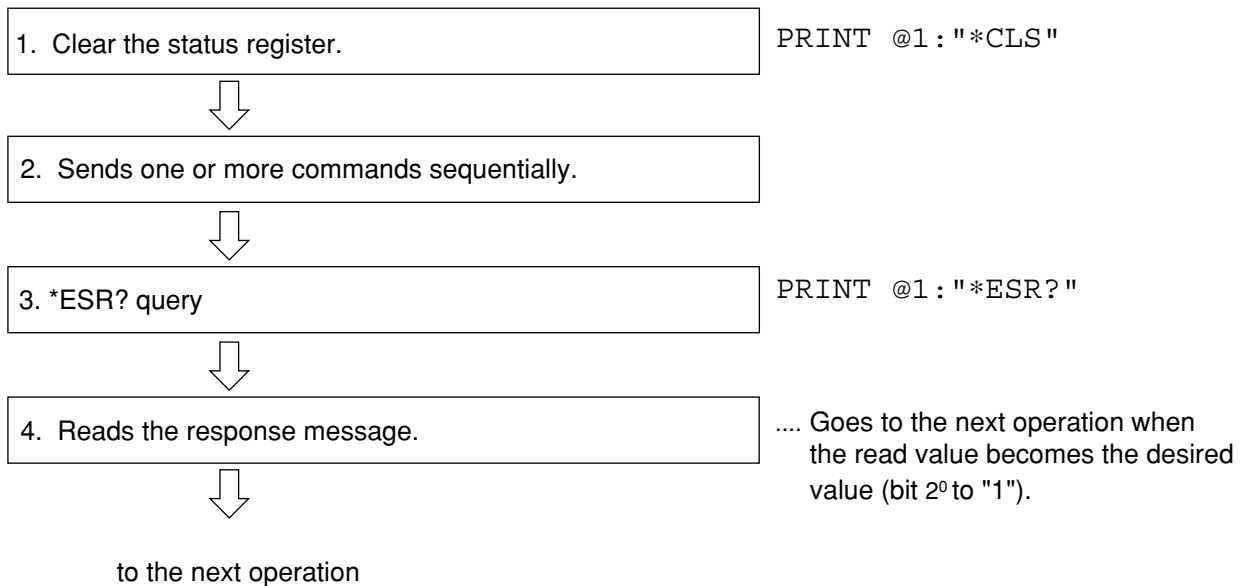

5.6.5 Wait for service request issuance from the status register

An event status register bit of the MT8801C is set to 1 when the corresponding event occurs. After setting these bits to set the RQS, the controller waits the SRQ for synchronization. Reset the event status register immediately before making a desired event occur.

• <Controller program 1: Synchronization by operation termination bit>

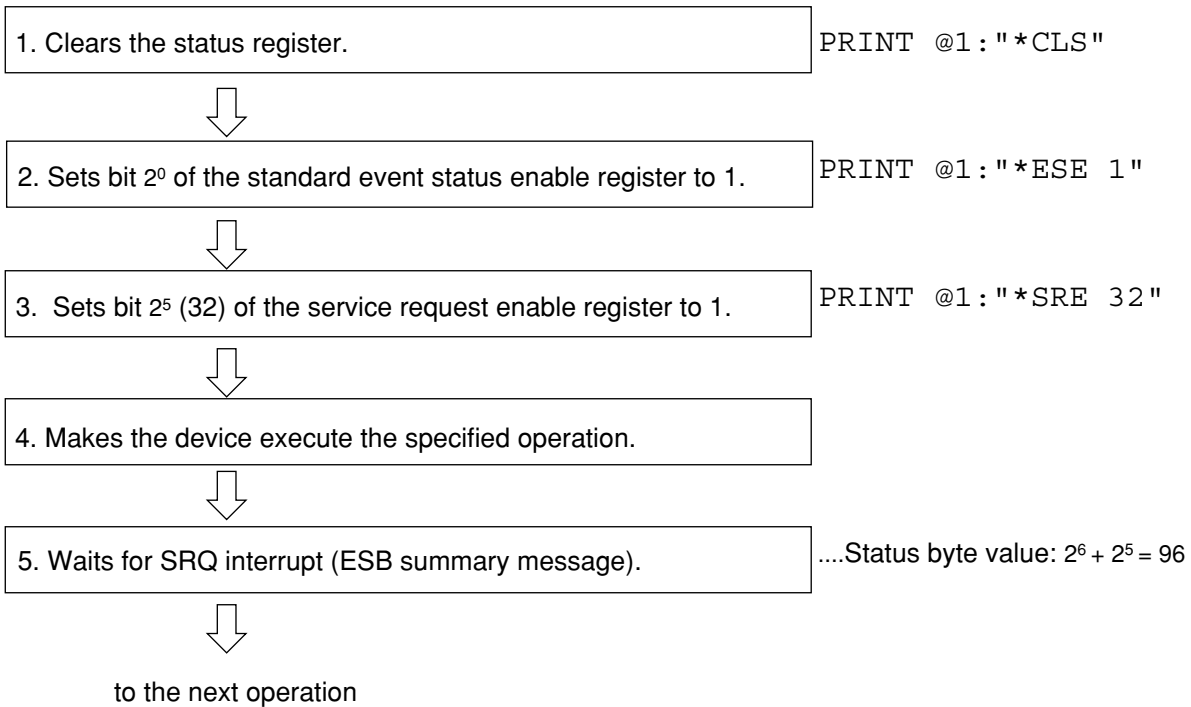

5.6 Techniques for Synchronizing the MT8801C with a Controller

• <Controller program 2: Synchronization by the sweep/measurement termination bit>

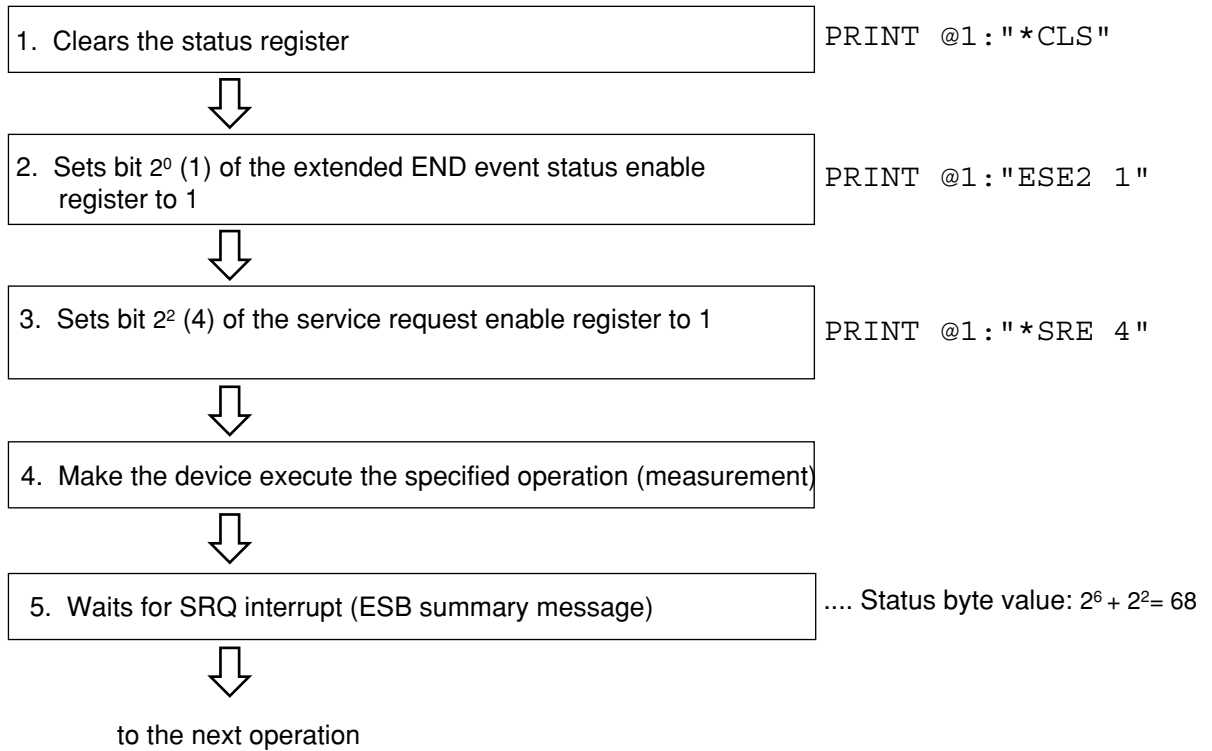

Section 5 Status Messages

Section 6 Initial Settings

This section outlines initialization for the system and describes how to initialize the system.

An example of initial settings are written for IBM-PC commands.

6.1	General Description	6-2
6.2	Bus Initialization by the IFC Statement	6-3
6.3	Initialization for Message Exchange by DCL and SDC Bus Commands	6-4
6.4	Device Initialization by the *RST Command	6-5
6.5	Device Initialization by the PRE/INI/IP Command	6-6
6.6	Device Status at Power-on	6-7

6.1 General Description

There are three levels of initialization for the GPIB system.

The first level is bus initialization using the IFC statement with the system bus in the idle state.

The second level is initialization for message exchange using the DCL command to enable devices to receive program messages.

The third level is device initialization using the PRE or *RST command to initialize device functions. These levels of initialization prepare a device for operation.

A device must be set to a known state when the power is switched on.

Level	Initialization type	Description	Level combination and sequence
1	Bus initialization	The IFC message from the controller initializes all interface functions connected to the bus.	Can be combined with other levels, level 1 must be executed before level 2.
2	Initialization for message exchange	The message exchanges of all devices and specified devices on the GPIB are initialized respectively by the DCL (Device Clear) and SDC (Select Device Clear) GPIB bus commands, which also nullify the function that reports to the controller that operation has completed.	Can be combined with other levels, level 2 must be executed before level 3.
3	Device initialization	The *RST or PRE/INI/IP command returns the specified device to the device-dependent known state, regardless of the conditions of previous device use.	Can be combined with other levels; level 3 must be executed after levels 1 and 2.

The following paragraph describes the commands for executing levels 1, 2, and 3, and the items initialized by execution. It also describes the known state which is set when the power is switched on.

When controlling with an external controller through the GPIB interface bus, all the initialization functions of the first/second/third levels can be used.

When controlling with an external controller through the RS-232C interface port, the initialization function of the third level (device initialization) can be used. The initialization functions of the first/second levels cannot be used.

6.2 Bus Initialization by the IFC Statement

■ Example

```
Call ibsic(ud%)
```

■ Explanation

The IFC statement initializes the interface functions of all devices connected to the GPIB bus line.

The initialization of interface functions involves erasing the settings (e.g. talker, listener) made by the controller and resetting to the initial states. In the table below, ○ indicates the initialized functions; Δ indicates partially initialized functions.

No	Function	Symbol	Initialization by IFC
1	Source handshake	SH	
2	Acceptor handshake	AH	○
3	Talker or extended talker	T or TE	○
4	Listener or extended listener	L or LT	○
5	Service request	SR	Δ
6	Remote/local	RL	
7	Parallel poll	PP	
8	Device clear	DC	
9	Device trigger	DT	
10	Controller	C	○

Bus initialization by the IFC statement does not affect the device-operating state (e.g. frequency settings, lamp on/off).

6.3 Initialization for Message Exchange by DCL and SDC Bus Commands

■ Example

```
Call ibclr(ud%)
```

Initializes only the device which is specified by ud% for message exchange (sending SDC)

■ Explanation

This statement executes initialization for message exchange by all devices or only the specified device on the GPIB of the specified select code.

■ Items to be initialized for message exchange

The MT8801C by which the DCL or SDC bus command is accepted executes the following:

[1] Input buffer and Output Queue:

Cleared; the MAV bit is also cleared at the same time.

[2] Parser, Execution Controller, and Response Formatter:

Reset

[3] Device commands including *RST:

Clears all commands that prevent these commands from executing.

[4] Processing the *OPC command:

Puts a device in OCIS (Operation Complete Command Idle State). As a result, the operation complete bit cannot be set in the Standard Event Status Register.

[5] Processing the *OPC query:

Puts a device in OQIS (Operation Complete Query Idle State). As a result, the operation complete bit 1 cannot be set in the Output Queue.

[6] Device function:

Puts sections relating to message exchange in an idle state. The device keeps waiting for a message from a controller.

Note:

The items listed below are not affected even if DCL and SDC bus command processing is executed:

- [1] The current data set or stored in the device
- [2] Front panel settings
- [3] Other status byte state except MAV bit
- [4] Device operation in progress

6.4 Device Initialization by the *RST Command

■ Syntax

```
*RST
```

■ Example

```
PCall ibwrt (ud%, "*RST")
```

Initializes the device (MT8801C) whose address is 1 with level 3.

■ Explanation

The *RST(Reset) command is an IEEE488.2 common command which resets a device with level 3.

The *RST (Reset) command is used to reset a device (MT8801C) to a specific initial state. Refer to the separate Operation Manual Appendix B for details of initialization items and initial values.

Note:

The *RST command does not affect the items listed below.

- [1] IEEE488.1 interface state
- [2] Device address
- [3] Output Queue
- [4] Service Request Enable register
- [5] Standard Event Status Enable register
- [6] Power-on-status-clear flag setting
- [7] Calibration data affecting device specifications
- [8] Parameters preset for controlling external devices, etc.

6.5 Device Initialization by the PRE/INI/IP Command

■ Syntax

```
PRE  
INI  
IP
```

■ Example (program message)

```
Call ibwrt (ud%, "PRE")
```

Initializes the device (MT8801C) whose address is 1 with level 3.

■ Explanation

The PRE, INI and IP commands are MT8801C device-dependent messages which initialize a device with level 3.

Refer to the separate Operation Manual Appendix B for details of items initialized by the PRE, INI, and IP commands and initial values.

6.6 Device Status at Power-on

When the power is switched on:

- [1] Preset value: When a power-off time (POWERON LAST) is selected, the device is set to the status before the last power off.
Preset value: When Recall memory No. (POWERON n) is selected, the device is set to file (number [n]) status.
- [2] The Input Buffer and Output Queue are cleared.
- [3] The Parser, Execution Controller, and Response Formatter are initialized.
- [4] The device is put into OCIS (Operation Complete Command Idle State).
- [5] The device is put into OQIS (Operation Complete Query Idle State).
- [6] The Standard Event Status and Standard Event Status Enable Registers are cleared. Events can be recorded after the registers have been cleared.

For the special case of [1], when the power supply is first turned on after the device is shipped, the initial values are set to those in the initial setting table (refer to separate Operation Manual Appendix B of the Option 01 Analog Measurement.)

Section 6 Initial Settings

Section 7 Sample Program

7.1 Notes on creating Program 7-2

7.1 Notes on creating Program

When a remote control program is creating, carefully note the following points.

No.	Key points	Explanation
1	Each device must be initialized.	<p>Each device is not always in the appropriate condition during actual usage due to operation of the device itself on the panel or the execution of other programs.</p> <p>Therefore, each device must be initialized to make the conditions at the start of usage constant.</p> <p>Do the following:</p> <p>[1] Initialize the interface function</p> <p>[2] Initialize the message exchange function of the device</p> <p>[3] Initialize the specific function of the device</p>
2	The remote condition of the device must be RWLS (Remote With Lock-out State).	<p>Device is set to local lockout to prevent the device returning to local.</p> <p>In the simple remote condition, when the [local] key is pressed, the device will enter the local condition. In this situation, if a panel key is pressed, auto-measurement will not function normally and measurement data may become unreliable.</p>
3	If an inquiry is sent, commands which are related to the device must not be sent immediately, except after the reading of result.	<p>Immediately after the inquiry command, the result of reading must be described in succession.</p> <p>If commands other than result reading are sent to the controller before the result of inquiry is read, and MLA is received, the output buffer will be cleared and the response message will be deleted.</p>
4	Program avoiding exceptional protocol operation	<p>No.3 above is one of the exceptional protocol operation, but try to avoid exceptional operation unless necessary.</p> <p>As for expected exceptions, set exception treatment parts in the program to avoid errors of stopping execution of the program.</p>
5	Confirmation of interface function (subset) of each device	<p>Confirm the subset of each device.</p> <p>When a program is executed for a device without the necessary subset, processing will not continue.</p> <p>Also check that the machine type conforms to IEEE488.2.</p>

Appendix

Appendix A ASCII Code Table	A-1
Appendix B Comparison Table of Controllers' GPIB Instructions	B-1
Appendix C Index	C-1

Appendix A ASCII Code Table

B7 B6 B5		0 0	0 0	0 1	0 1	1 0	1 0	1 1	1 1										
BITS B4 B3 B2 B1		CONTROL		NUMBERS SYMBOLS		UPPER CASE		LOWER CASE											
0	0	0	0	0	NUL	20	DLE	40	SP	60	0	100	@	120	P	140	,	160	p
0	0	0	1	1	SOH ^{GTL}	21	DC1 ^{LLO}	41	!	61	1	101	A	121	Q	141	a	161	q
0	0	1	0	2	NUL	22	DC2	42	"	62	2	102	B	122	R	142	b	162	r
0	0	1	1	3	ETX	23	DC3	43	#	63	3	103	C	123	S	143	c	163	s
0	1	0	0	4	EOT ^{SDC}	24	DC4 ^{DCL}	44	\$	64	4	104	D	124	T	144	d	164	t
0	1	0	1	5	ENO ^{PPC}	25	NAK ^{PPU}	45	%	65	5	105	E	125	U	145	e	165	u
0	1	1	0	6	ACK	26	SYN	46	&	66	6	106	F	126	V	146	f	166	v
0	1	1	1	7	BEL	27	ETB	47	'	67	7	107	G	127	W	147	g	167	w
1	0	0	0	8	BS ^{GET}	30	CAN ^{SPE}	50	(70	8	110	H	130	X	150	h	170	x
1	0	0	1	9	HT ^{TCT}	31	EM ^{SPD}	51)	71	9	111	I	131	Y	151	i	171	y
1	0	1	0	10	LF	32	SUB	52	*	72	:	112	J	132	Z	152	j	172	z
1	0	1	1	11	VT	33	ESC	53	÷	73	;	113	K	133	[153	k	173	{
1	1	0	0	12	FF	34	FS	54	,	74	<	114	L	134	\	154	l	174	'
1	1	0	1	13	CR	35	GS	55	—	75	=	115	M	135]	155	m	175	}
1	1	1	0	14	SO	36	RS	56	.	76	>	116	N	136	^	156	n	176	~
1	1	1	1	15	SI	37	US	57	/	77	?	117	O	137	UNT	157	o	177	RUBOUT (DEL)
		Address command		Universal command		Listen address		Talk address		Secondary address or command									

KEY octal 25 PPU
NAK
hex 15 21

GIPIB code
ASCII character
decimal

*American Standard Code for Information Interchange

Notes:

- [1] MSG=INTERFACE MESSAGE (Sent by ATN of True, Low level)
- [2] b1=DI01...b7=DI07 (b1 through b7 correspond to DI01 to DI07 sequence.)GTL
- SDC Go to Local
- PPC Select Device Clear
- GET Parallel Poll Configure
- TCT Group Execute Trigger
- LLO Take Control
- DCL Local Lockout
- PPU Device Clear
- SPE Parallel Poll Unconfigure
- SPD Serial Poll Enable
- UNL Serial Poll Disable
- UNT Unlisten
- (ACG) Untalk
- (UCG) Addressed Command Group
- (LAG) Universal Command Group
- (TAG) Listen Address Group
- (PCG) Talk Address Group
- (SCG) Primary Command Group
- Secondary Command Group

Table A-2 Interface Message Groups

D 1 0 8	D 1 0 7	D 1 0 6	D 1 0 5	D 1 0 4	D 1 0 3	D 1 0 2	D 1 0 1	Interface message group (G)
×	0	0	0	b4	b3	b2	b1	Addressed command G
×	0	0	1	b4	b3	b2	b1	Universal command G
×	0	1	b5	b4	b3	b2	b1	Listen address G
×	0	1	1	1	1	1	1	Unlisten (UNL)
×	1	0	b5	b4	b3	b2	b1	Talker Address G
×	1	0	1	1	1	1	1	Untalk (UNT)
×	1	1	b5	b4	b3	b2	b1	Secondary command G

Table A-3 Address Assignments

Address character		Address switch setting					Primary address	Factory address set device
Talk	Listen	5	4	3	2	1		
b7 b6	b7 b6	b5	b4	b3	b2	b1		
1 0	0 1	↓	↓	↓	↓	↓	Decimal	
@	SP	0	0	0	0	0	0	
A	!	0	1	0	0	1	1	
B	"	0	0	0	1	0	2	
C	#	0	0	0	1	1	3	
D	\$	0	0	1	0	0	4	
E	%	0	0	1	0	1	5	
F	&	0	0	1	1	0	6	
G	'	0	0	1	1	1	7	
H	(0	1	0	0	0	8	
I)	0	1	0	0	1	9	
J	*	0	1	0	1	0	10	
K	+	0	1	0	1	1	11	
L	,	0	1	1	0	0	12	
M	-	0	1	1	0	1	13	Printer Plotter
N	.	0	1	1	1	0	14	
O	/	0	1	1	1	1	15	
P	0	1	0	0	0	0	16	
Q	1	1	0	0	0	1	17	
R	2	1	0	0	1	0	18	
S	3	1	0	0	1	1	19	
T	4	1	0	1	0	0	20	
U	5	1	0	1	0	1	21	
V	6	1	0	1	1	0	22	
W	7	1	0	1	1	1	23	
X	8	1	1	0	0	0	24	
Y	9	1	1	0	0	1	25	
Z	:	1	1	0	1	0	26	
[;	1	1	0	1	1	27	
\	<	1	1	1	0	0	28	
]	=	1	1	1	0	1	29	
^	>	1	1	1	1	0	30	
?	-	1	1	1	1	1	31	UNL,UNT

Appendix B Comparison Table of Controllers' GPIB Instructions

Function	Controller			
	PACKET V (Anritsu)	PC-9800 series (NEC)	IBM-PC	HP9000 series
Outputs data to a device Outputs binary data to a device	WRITE @ device number; data BIN WRITE @ device number; data	PRINT @ listener address; data WBYTE command;data	CALL IBWRT()	OUTPUT device selector;data
Assigns data entered from a device to a variable	READ @ device number;variable	INPUT @ talker address, listener address;variable LINE INPUT @ talker address, listener address;variable	CALL IBRD()	ENTER device selector;variable
Assigns binary data entered from a device to a variable	BIN READ @ device number; variable	RBYTE command;variable		
Initializes an interface function	IFC @ select code	ISET IFC	CALL IBSIC()	ABORT select code
Turns REN line on	REN @ select code	ISET REN	CALL IBSRE()	REMOTE device selector (select code)
Turns REN line off	LCL @ select code (sets all devices local) LCL @ device number (sets only specified devices to listeners, and sends out GTL command)	IRESET REN WBYTE &H3F,listener address,secondary address,&H01;	CALL IBSRE() CALL IBLOC()	LOCAL device selector (select code) LOCAL device selector (select code + primary address)
Outputs interface messages (messages) and data	COMMAND @ select code : character string for message [:data]		CALL IBCMD() CALL IBCMDA() (asynchronous)	SEND select code ;message string
Triggers a specified device	TRG @ device number	WBYTE &H3F,listener address,secondary address,&H08;	CALL IBTRG()	TRIGGER device selector

Appendix B Comparison Table of Controllers' GPIB Instructions

Function	Controller			
	PACKET V (Anritsu)	PC-9800 series (NEC)	IBM-PC	HP9000 series
Initializes devices	DCL @ select code (all devices bearing a specified select code) DCL @ device number (specified devices only)	WBYTE &H3F,&H14; WBYTE &H3F, listener address, secondary address,&H04;	CALL IBCLR()	CLEAR device selector (selector code) CLEAR device selector (selector code + primary address)
Disables a device from being switched over from remote to local	LLO @ select code	WBYTE &H3F, &H11;		LOCAL LOCKOUT
Transfers control to a specified device	RCT @ device number	WBYTE talker address, &H09;	CALL IBPCT()	PASS CONTROL
Sends out a service request	SRQ @ select code	ISSET SRQ	CALL IBRSV()	REQUEST select code
Performs serial polling	STATUS @ device number	POLL	CALL IBRSP()	SPOLL (device selector) (function)
Sets a terminator code	TERM IS	CMD DELIM	CALL IBEOS() CALL IBEOT()	
Sets a limit value for checking a timeout		CMD TIMEOUT	CALL IBTOM()	

Appendix C Index

The numbers on the right indicate section and paragraph numbers in this operation manual.

ASCII code table	APPENDIX A
Bit definition of END event status register	5.5.1
Bit definition of ERR event status register	5.5.2
Bit definition of standard event status register	5.4.1
Bus initialization by the IFC statement	6.2
Character program data	4.2 (5), 4.3 (5)
Clearing the STB register by the *CLS common command	5.2.3 (4)
Connecting Devices with GPIB Cables	3.1
Connection	3
Connection of RS-232C interface signal	3.3
Definition of MSS	5.2.3 (3)
Device initialization by PRE/INI/IP command	6.5
Device initialization by the *RST command	6.4
Device message format	4
Device messages	2
Device status at power-on	6.6
Device-dependent summary messages	5.2.2
ESB and MAV summary messages	5.2.1
ESB summary message	5.2.1 (1)
Example of system configuration using RS-232C/GPIB	1.3
Extended event status register	5.5
GPIB commands of Audio Test	2.5
GPIB instruction comparison table of the controller	APPENDIX B
GPIB specifications	2.3
IEEE488.2 common commands and supported commands	5.1
Initial setting	6
Initialization for message exchange by DCL and SDC statements	6.3
MAV summary messages	5.2.1 (2)
Overview	1.1
Overview (device message)	2.1
Overview (device message format)	4.1
Program data	4.2 (4)
Program message	4.2 (2)
Program message format	4.2
Program message terminator	4.2 (1)
Program message unit	4.2 (3)
Query error details	5.4.2
Reading and clearing the STB register	5.2.3

Appendix C Index

Reading by the *STB common query	5.2.3 (2)
Reading by using serial polling	5.3.3 (1)
Reading the SRE register	5.3 (1)
Reading, writing, and clearing the extended event status enable register	5.5.4
Reading, writing, and clearing the extended event status register	5.5.3
Reading, writing to and clearing the standard event status enable register	5.4.4
Reading, writing to and clearing the standard event status register	5.4.3
Remote control functions	1.2
Response data	4.3 (4)
Response message	4.3(2)
Response message format	4.3
Response message terminator	4.3 (1)
Response message to input the waveform data using binary data	4.3 (8)
Response message unit	4.3 (3)
Response wait by the status register	5.6.4
RS-232C specifications	1.4
Service request enable operation	5.3
Service request wait by the status register	5.6.5
Setting RS-232C interface conditions	3.4
Setting the addresses	3.2
Setting the items relating to remote control and panel key control	3.5
Standard event status register	5.4
Status byte (STB) register	5.2
Status messages	2.4, 5
String program data	4.2 (7)
String response data	4.3 (7)
Suffix code	2.2
Techniques for synchronizing the MT8801C with a controller	5.6
Updating the SRE register	5.3 (1)
Value program data	4.2 (6)
Value response data	4.3 (6)
Wait for response after *OPC? query is sent	5.6.2
Wait for response by executing the SWP or TS command	5.6.1
Wait for service request by the *OPC command	5.6.3